

Mini DC - Isolators for Photovoltaic

acc. to IEC 60364-7-712



Quality made  AUSTRIA

D1080E241



**Contactors
Motor-Starters**

Mini-Contactors
Contactors
Overload Relays
Compacitor Switching Contactors
Motor-Starters
Modular Contactors

Catalogue **D677E..**



**Circuit
Breakers**

M4-32T.. up to 32A
M4-32R.. up to 32A
M4-63R.. up to 63A
M4-100R.. up to 100A

Catalogue **D795E..**



Switches

On-Off-Switches
Changeover Switches
Motor Switches
Step Switches
Main Switches
Modular Switches
Key Operated Switches

Catalogue **D371E..**



**Main
Switches**

Emergency Off
Main Switches
On-Off-Switches
Add-On-Module

Catalogue **D656E..**



**Capacitor Switching
Contactors**

Contactors for reactive and non reactive capacitor banks

Catalogue **D385E..**

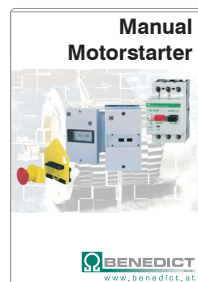

**Manual
Motorstarter**

MU25A up to 32A

Auxiliary Contact Blocks
Trip Alarm Auxiliary Switches
Busbar Connectors
Enclosure

Catalogue **D509E..**



Push Buttons

Push Buttons
Emergency Stop
Key Operated Rotary Switches
Rotary Knobs
Illuminated Push Buttons
Assembled Stations

Catalogue **D580E..**

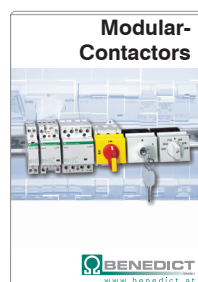

**Modular-
Contactors**

Modular Contactors
Accessories
Emergency Off Switches
Main Switches
On-Off Switches
Control Switches

Catalogue **D681E..**

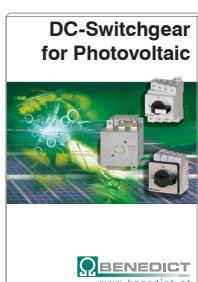

**DC-Switchgear
for Photovoltaic**

Main Switches
On-Off-Switches
Contactors for DC-Switching

Catalogue **D911E..**



**Low Voltage
Control Gear**

Contactors
D.O.L. Starter
Overload Relays
Manual Motor Starter
Main Switches
Cam Switches
Push Buttons
Emergency Stop

Catalogue **D651E..**



Content

Page



Mini DC-Isolators for Panel Mounting (4 holes)
Lockable Mini DC-Isolators for Panel Mounting (4 holes)

6
6



Mini DC-Isolators for Panel Mounting (2 holes)
Lockable Mini DC-Isolators for Panel Mounting (2 holes)

7
7

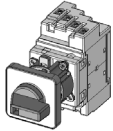

Mini DC-Isolators for Single Hole Mounting (Ø22,5mm)
Lockable Mini DC-Isolators for Single Hole Mounting (Ø22,5mm)

8
9

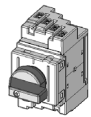

Mini DC-Isolators for Single Hole Mounting (Ø16mm)
Lockable Mini DC-Isolators for Single Hole Mounting (Ø16mm)

9
10



Mini DC-Isolators for Base Mounting
Lockable Mini DC-Isolators for Base Mounting

10
11

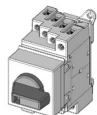

Mini DC-Isolators for Distribution Boards
Lockable Mini DC-Isolators for Distribution Boards

11
12

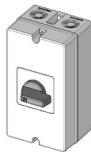

Lockable Mini DC-Isolators in Plastic Enclosure

12

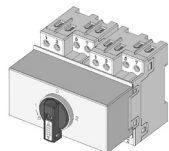

Changeover Isolators for Panel Mounting, Base Mounting,
Modular Switches

13 - 14



Technical Data
Approvals
Dimensions

15 - 20
19
20 - 29

Ratings

Rated Current

Type	I_{th} open A	DC21B(DC-PV1) 4 poles in series A	at U_e V
LSA16	16	16	1500
LSA25	25	25	1500
LSA32	32	32	1500
LSA38	45	45	1500

Type	I_{th} open A	DC21B(DC-PV1) 4 poles in series A	at U_e V	Design	Panel mounting 4 hole mounting IP66 ¹⁾ $\leq U_{us}$ Type 3R	Panel mounting 2 hole mounting IP66 ¹⁾ $\leq U_{us}$ Type 3R	Single hole $\varnothing 22,5\text{mm}$ IP66 ¹⁾ $\leq U_{us}$ Type 4X	Single hole $\varnothing 16\text{mm}$ IP66 ¹⁾ $\leq U_{us}$ Type 4X
LSMO16	16	16	1500	..E, EH4..	..E, EH4..	..E2, E2H1..	..Z(O), ZH1..	..Z16, Z16H448..
LSMO25	25	25	1500	..E, EH4..	..E, EH4..	..E2, E2H1..	..Z(O), ZH1..	..Z16, Z16H448..
LSMO32	32	32	1500	..E, EH4..	..E, EH4..	..E2, E2H1..	..Z(O), ZH1..	..Z16, Z16H448..
LSMO38	45	45	1500	..E, EH4..	..E, EH4..	..E2, E2H1..	..Z(O), ZH1..	..Z16, Z16H448..

Mini DC-Switch Disconnectors

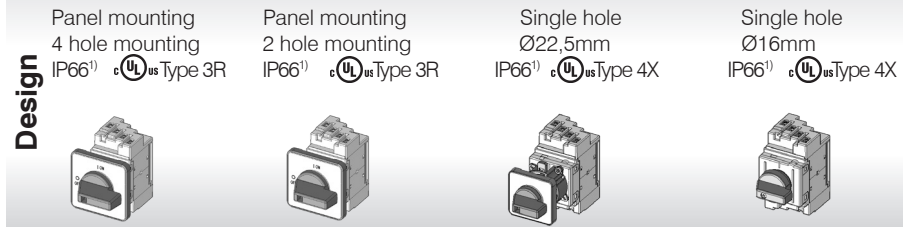

Mini Switch Disconnectors for Photovoltaic

Mini Switch Disconnectors „LSA“ are switch gears for interrupting the DC/AC-Inverter from solar-panels. Photovoltaic-Installations have to be equipped with DC-Isolators acc. to IEC 60364-7-712.

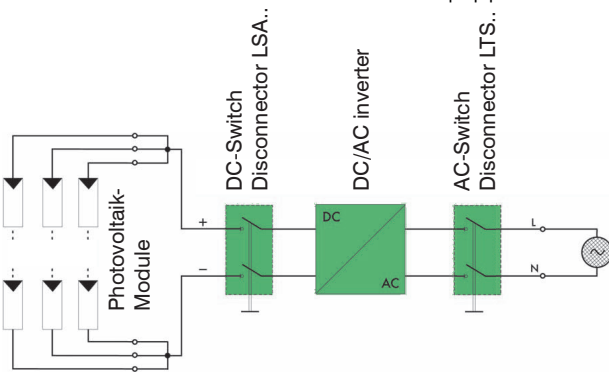

Mini Switch Disconnectors LSA ensure a reliable switching up to 50A at 1200V in the category DC-PV1 (= DC21B).

The construction of the contacts and the material selection guarantee that no oxidations develop (because of small switching frequency) and further it is prevented that inadmissible heating-up is effected.

Mini Switch Disconnectors LSA are equipped with 2 or 4 switchable, singular contacts. By serial or parallel wiring of the contacts the contact rating will be increased. The switching speed by the manually driven handle does not have an effect on the switching attitude of the contacts.

Mounting positions:

No limitations, all kind of positions allowed.

Switching programs

Type	2-pole	2+2-pole 2 poles in series + 2 Pole parallel	4-pole	4-pole 2 jumpers top Input and Output bottom	4-pole 2 jumpers bottom Input and Output top
LSA16 ... LSA38	.. A2	.. A2+2	.. A4(2 x A2)	.. A4O	.. A4U

Contact
Wiring diagram

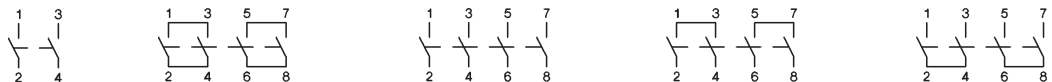

Switching example

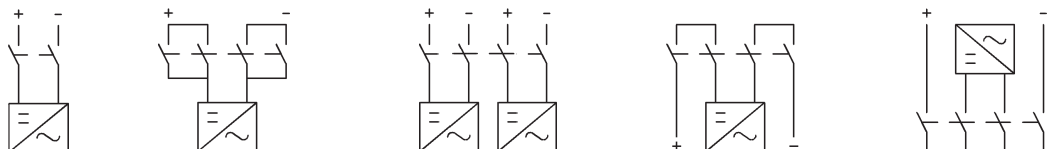

Ordering

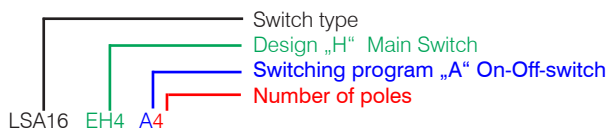

1) Protection in front and built in

Mini DC-Switch Disconnectors

Base mounting with door coupling, single hole, Ø22,5mm, IP66¹⁾ 

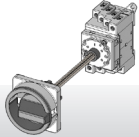

Modular Switch IP40¹⁾ 

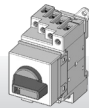

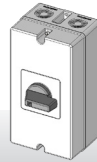

Plastic enclosed PFL..IP67¹⁾ 



..VZV, VZVH4..	..SMA, SMAH1N..	..PFLH4..
..VZV, VZVH4..	..SMA, SMAH1N..	..PFLH4..
..VZV, VZVH4..	..SMA, SMAH1N..	..PFLH4..
..VZV, VZVH4..	..SMA, SMAH1N..	..PFLH4..
..VZV, VZVH4..	..SMA, SMAH1N..	..PFLH4..

Technical data for DC, acc. to IEC 60947-3, VDE0660

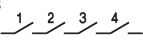
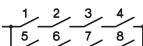
Type			DC-PV1 (= DC21B)							DC-PV2				
			500V	600V	700V	800V	900V	1000V	1200V	1500V	500V	600V	800V	1000V
2 Poles in Series 	LSA16..	A	16	16	16	16	16	10	7	3	16	14	12	4
	LSA25..	A	25	25	25	20	17	11,5	8,5	5	25	21	15	5
	LSA32..	A	32	32	32	23	20	13	10	6	32	27	17	6
	LSA38..	A	45	45	36	30	25	20	10	6	38	31	19	7
2 Poles in Series + 2 parallel 	LSA16..	A	29	29	22	17	16	10	7	3	25	20	12	4
	LSA25..	A	45	36	27	20	17	11,5	8,5	5	39	32	15	5
	LSA32..	A	50	50	32	23	20	13	10	6	50	35	17	6
	LSA38..	A	50	50	36	30	25	20	10	6	50	38	19	7
4 Poles in Series 	LSA16..	A	16	16	16	16	16	16	16	16	16	16	16	16
	LSA25..	A	25	25	25	25	25	25	25	25	25	25	25	
	LSA32..	A	32	32	32	32	32	32	32	32	32	32	32	
	LSA38..	A	45	45	45	45	45	38	32	32	45	45	38	38
4 Poles in Series + 2 parallel 	LSMO16..	A	29	29	29	29	29	29	29	20	29	29	21	16
	LSMO25..	A	45	45	45	45	45	45	33	26	45	45	35	25
	LSMO32..	A	50	50	50	50	50	50	50	32	50	50	45	32
	LSMO38..	A	50	50	50	50	50	50	50	32	50	50	50	50

Switching programs

Type

6-poles

8-poles

LSMO16 ... LSMO38

...A6

...A8

Contact
Wiring diagram

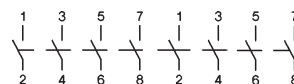
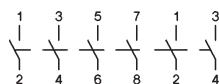

Switching example

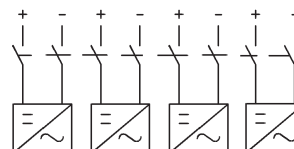
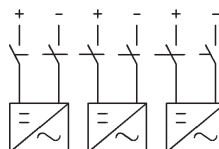

Isolated jumpers LSAV-.. and LSMOV-.. for Series and Parallel switching of contacts (terminals 1-3, 5-7, 2-4, 6-8). Details see page 30.

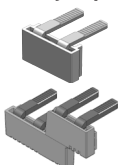

for switches

Type

VPE

weight

LSA(O)16 ... LSA(O)25 (A4O, A4U, A2+2)	LSAV-B1-1	100	4,80 g/pce.
LSA(O)32 ... LSA(O)38 (A4O, A4U, A2+2)	LSAV-B1-2	100	9,00 g/pce.
LSMO16 ... LSMO25 (A4+2)	LSMOV-B1	100	8,90 g/pce.

1) Protection in front and built in

Mini DC-Isolators for Panel Mounting, 4 holes, Plate 64, IP66, Type 3R

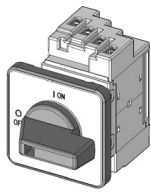

DC-PV1 (=DC21B)		Poles in Series	Number of Strings	Type	Pack pcs.	Weight kg/pce.
600V	1000V					
16A	10A	2	1	LSA16 E A2	1	0,18
25A	11,5A	2	1	LSA25 E A2	1	0,18
32A	13A	2	1	LSA32 E A2	1	0,18
45A	20A	2	1	LSA38 E A2	1	0,18
29A	10A	2	1	LSA16 E A2+2	1	0,24
36A	11,5A	2	1	LSA25 E A2+2	1	0,24
50A	13A	2	1	LSA32 E A2+2	1	0,24
50A	20A	2	1	LSA38 E A2+2	1	0,24
16A	16A	2	2	LSA16 E A4	1	0,23
25A	25A	2	2	LSA25 E A4	1	0,23
32A	32A	2	2	LSA32 E A4	1	0,23
45A	38A	2	2	LSA38 E A4	1	0,23
16A	16A	4	1	LSA16 E A4O	1	0,25
25A	25A	4	1	LSA25 E A4O	1	0,25
32A	32A	4	1	LSA32 E A4O	1	0,25
45A	38A	4	1	LSA38 E A4O	1	0,25
16A	16A	4	1	LSA16 E A4U	1	0,25
25A	25A	4	1	LSA25 E A4U	1	0,25
32A	32A	4	1	LSA32 E A4U	1	0,25
45A	38A	4	1	LSA38 E A4U	1	0,25

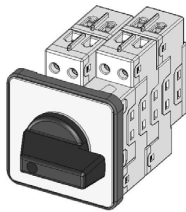

16A	10A	2	3	LSMO16 E A6	1	0,50
25A	11,5A	2	3	LSMO25 E A6	1	0,50
32A	13A	2	3	LSMO32 E A6	1	0,50
45A	20A	2	3	LSMO38 E A6	1	0,50
16A	10A	2	4	LSMO16 E A8	1	0,52
25A	11,5A	2	4	LSMO25 E A8	1	0,52
32A	13A	2	4	LSMO32 E A8	1	0,52
45A	20A	2	4	LSMO38 E A8	1	0,52

Lockable Mini DC-Isolators for Panel Mounting, 4 holes, Plate 64, IP66, Type 3R LISTED

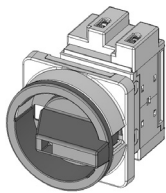

16A	10A	2	1	LSA16 EH4 A2	1	0,19
25A	11,5A	2	1	LSA25 EH4 A2	1	0,19
32A	13A	2	1	LSA32 EH4 A2	1	0,19
45A	20A	2	1	LSA38 EH4 A2	1	0,19
29A	10A	2	1	LSA16 EH4 A2+2	1	0,25
36A	11,5A	2	1	LSA25 EH4 A2+2	1	0,25
50A	13A	2	1	LSA32 EH4 A2+2	1	0,25
50A	20A	2	1	LSA38 EH4 A2+2	1	0,25
16A	16A	2	2	LSA16 EH4 A4	1	0,24
25A	25A	2	2	LSA25 EH4 A4	1	0,24
32A	32A	2	2	LSA32 EH4 A4	1	0,24
45A	38A	2	2	LSA38 EH4 A4	1	0,24
16A	16A	4	1	LSA16 EH4 A4O	1	0,26
25A	25A	4	1	LSA25 EH4 A4O	1	0,26
32A	32A	4	1	LSA32 EH4 A4O	1	0,26
45A	38A	4	1	LSA38 EH4 A4O	1	0,26
16A	16A	4	1	LSA16 EH4 A4U	1	0,26
25A	25A	4	1	LSA25 EH4 A4U	1	0,26
32A	32A	4	1	LSA32 EH4 A4U	1	0,26
45A	38A	4	1	LSA38 EH4 A4U	1	0,26

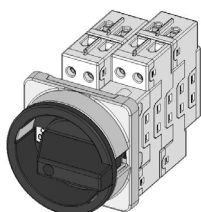

16A	10A	2	3	LSMO16 EH4 A6	1	0,51
25A	11,5A	2	3	LSMO25 EH4 A6	1	0,51
32A	13A	2	3	LSMO32 EH4 A6	1	0,51
45A	20A	2	3	LSMO38 EH4 A6	1	0,51
16A	10A	2	4	LSMO16 EH4 A8	1	0,53
25A	11,5A	2	4	LSMO25 EH4 A8	1	0,53
32A	13A	2	4	LSMO32 EH4 A8	1	0,53
45A	20A	2	4	LSMO38 EH4 A8	1	0,53

Mini DC-Isolators for Single Hole Mounting, 2 holes, Plate 64, IP66, Type 3R

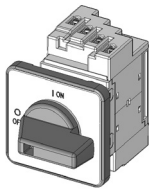

DC-PV1 (=DC21B)		Poles in Series	Number of Strings	Type	Pack pcs.	Weight kg/pce.
600V	1000V					
16A	10A	2	1	LSA16 E2 A2	1	0,18
25A	11,5A	2	1	LSA25 E2 A2	1	0,18
32A	13A	2	1	LSA32 E2 A2	1	0,18
45A	20A	2	1	LSA38 E2 A2	1	0,18
29A	10A	2	1	LSA16 E2 A2+2	1	0,24
36A	11,5A	2	1	LSA25 E2 A2+2	1	0,24
50A	13A	2	1	LSA32 E2 A2+2	1	0,24
50A	20A	2	1	LSA38 E2 A2+2	1	0,24
16A	16A	2	2	LSA16 E2 A4	1	0,23
25A	25A	2	2	LSA25 E2 A4	1	0,23
32A	32A	2	2	LSA32 E2 A4	1	0,23
45A	38A	2	2	LSA38 E2 A4	1	0,23
16A	16A	4	1	LSA16 E2 A4O	1	0,25
25A	25A	4	1	LSA25 E2 A4O	1	0,25
32A	32A	4	1	LSA32 E2 A4O	1	0,25
45A	38A	4	1	LSA38 E2 A4O	1	0,25
16A	16A	4	1	LSA16 E2 A4U	1	0,25
25A	25A	4	1	LSA25 E2 A4U	1	0,25
32A	32A	4	1	LSA32 E2 A4U	1	0,25
45A	38A	4	1	LSA38 E2 A4U	1	0,25
16A	10A	2	3	LSMO16 E2 A6	1	0,50
25A	11,5A	2	3	LSMO25 E2 A6	1	0,50
32A	13A	2	3	LSMO32 E2 A6	1	0,50
45A	20A	2	3	LSMO38 E2 A6	1	0,50
16A	10A	2	4	LSMO16 E2 A8	1	0,52
25A	11,5A	2	4	LSMO25 E2 A8	1	0,52
32A	13A	2	4	LSMO32 E2 A8	1	0,52
45A	20A	2	4	LSMO38 E2 A8	1	0,52

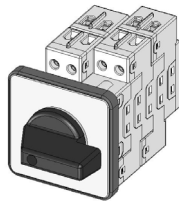

Mini DC-Isolators for Panel Mounting, 2 holes, Plate 64, IP66, Type 3R

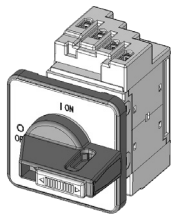

16A	10A	2	1	LSA16 E2H1 A2	1	0,19
25A	11,5A	2	1	LSA25 E2H1 A2	1	0,19
32A	13A	2	1	LSA32 E2H1 A2	1	0,19
45A	20A	2	1	LSA38 E2H1 A2	1	0,19
29A	10A	2	1	LSA16 E2H1 A2+2	1	0,25
36A	11,5A	2	1	LSA25 E2H1 A2+2	1	0,25
50A	13A	2	1	LSA32 E2H1 A2+2	1	0,25
50A	20A	2	1	LSA38 E2H1 A2+2	1	0,25
16A	16A	2	2	LSA16 E2H1 A4	1	0,24
25A	25A	2	2	LSA25 E2H1 A4	1	0,24
32A	32A	2	2	LSA32 E2H1 A4	1	0,24
45A	38A	2	2	LSA38 E2H1 A4	1	0,24
16A	16A	4	1	LSA16 E2H1 A4O	1	0,26
25A	25A	4	1	LSA25 E2H1 A4O	1	0,26
32A	32A	4	1	LSA32 E2H1 A4O	1	0,26
45A	38A	4	1	LSA38 E2H1 A4O	1	0,26
16A	16A	4	1	LSA16 E2H1 A4U	1	0,26
25A	25A	4	1	LSA25 E2H1 A4U	1	0,26
32A	32A	4	1	LSA32 E2H1 A4U	1	0,26
45A	38A	4	1	LSA38 E2H1 A4U	1	0,26
16A	10A	2	3	LSMO16 E2H1 A6	1	0,51
25A	11,5A	2	3	LSMO25 E2H1 A6	1	0,51
32A	13A	2	3	LSMO32 E2H1 A6	1	0,51
45A	20A	2	3	LSMO38 E2H1 A6	1	0,51
16A	10A	2	4	LSMO16 E2H1 A8	1	0,53
25A	11,5A	2	4	LSMO25 E2H1 A8	1	0,53
32A	13A	2	4	LSMO32 E2H1 A8	1	0,53
45A	20A	2	4	LSMO38 E2H1 A8	1	0,53

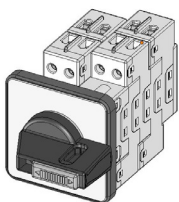

Mini DC-Isolators for Single Hole Mounting, Ø22,5mm, Plate 48, IP66, Type 4X cUL_{us}

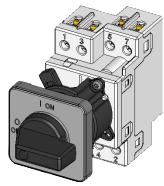

DC-PV1 (=DC21B)		Poles in Series	Number of Strings	Type	Pack pcs.	Weight kg/pce.
600V	1000V					
16A	10A	2	1	LSA16 Z A2	1	0,17
25A	11,5A	2	1	LSA25 Z A2	1	0,17
32A	13A	2	1	LSA32 Z A2	1	0,17
45A	20A	2	1	LSA38 Z A2	1	0,17
29A	10A	2	1	LSA16 Z A2+2	1	0,22
36A	11,5A	2	1	LSA25 Z A2+2	1	0,22
50A	13A	2	1	LSA32 Z A2+2	1	0,22
50A	20A	2	1	LSA38 Z A2+2	1	0,22
16A	16A	2	2	LSA16 Z A4	1	0,21
25A	25A	2	2	LSA25 Z A4	1	0,21
32A	32A	2	2	LSA32 Z A4	1	0,21
45A	38A	2	2	LSA38 Z A4	1	0,21
16A	16A	4	1	LSA16 Z A4O	1	0,23
25A	25A	4	1	LSA25 Z A4O	1	0,23
32A	32A	4	1	LSA32 Z A4O	1	0,23
45A	38A	4	1	LSA38 Z A4O	1	0,23
16A	16A	4	1	LSA16 Z A4U	1	0,23
25A	25A	4	1	LSA25 Z A4U	1	0,23
32A	32A	4	1	LSA32 Z A4U	1	0,23
45A	38A	4	1	LSA38 Z A4U	1	0,23
16A	10A	2	3	LSMO16 Z A6	1	0,50
25A	11,5A	2	3	LSMO25 Z A6	1	0,50
32A	13A	2	3	LSMO32 Z A6	1	0,50
45A	20A	2	3	LSMO38 Z A6	1	0,50
16A	10A	2	4	LSMO16 Z A8	1	0,52
25A	11,5A	2	4	LSMO25 Z A8	1	0,52
32A	13A	2	4	LSMO32 Z A8	1	0,52
45A	20A	2	4	LSMO38 Z A8	1	0,52

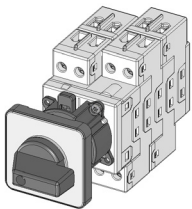

Mini DC-Isolators for Single Hole Mounting, Ø22,5mm, without Plate, IP66, Type 4X cUL_{us}

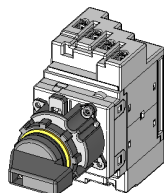

16A	10A	2	1	LSA16 ZO A2	1	0,15
25A	11,5A	2	1	LSA25 ZO A2	1	0,15
32A	13A	2	1	LSA32 ZO A2	1	0,15
45A	20A	2	1	LSA38 ZO A2	1	0,15
29A	10A	2	1	LSA16 ZO A2+2	1	0,19
36A	11,5A	2	1	LSA25 ZO A2+2	1	0,19
50A	13A	2	1	LSA32 ZO A2+2	1	0,19
50A	20A	2	1	LSA38 ZO A2+2	1	0,19
16A	16A	2	2	LSA16 ZO A4	1	0,18
25A	25A	2	2	LSA25 ZO A4	1	0,18
32A	32A	2	2	LSA32 ZO A4	1	0,18
45A	38A	2	2	LSA38 ZO A4	1	0,18
16A	16A	4	1	LSA16 ZO A4O	1	0,19
25A	25A	4	1	LSA25 ZO A4O	1	0,19
32A	32A	4	1	LSA32 ZO A4O	1	0,19
45A	38A	4	1	LSA38 ZO A4O	1	0,19
16A	16A	4	1	LSA16 ZO A4U	1	0,19
25A	25A	4	1	LSA25 ZO A4U	1	0,19
32A	32A	4	1	LSA32 ZO A4U	1	0,19
45A	38A	4	1	LSA38 ZO A4U	1	0,19
16A	10A	2	3	LSMO16 ZO A6	1	0,45
25A	11,5A	2	3	LSMO25 ZO A6	1	0,45
32A	13A	2	3	LSMO32 ZO A6	1	0,45
45A	20A	2	3	LSMO38 ZO A6	1	0,45
16A	10A	2	4	LSMO16 ZO A8	1	0,47
25A	11,5A	2	4	LSMO25 ZO A8	1	0,47
32A	13A	2	4	LSMO32 ZO A8	1	0,47
45A	20A	2	4	LSMO38 ZO A8	1	0,47

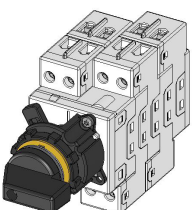

Mini DC-Isolators for Single Hole Mounting, Ø22,5mm, Plate 48, IP66, Type 4X

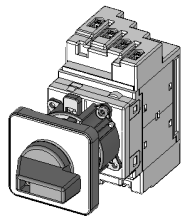

DC-PV1 (=DC21B)		Poles in Series	Number of Strings	Type	Pack pcs.	Weight kg/pce.
600V	1000V					
16A	10A	2	1	LSA16 ZH1 A2	1	0,17
25A	11,5A	2	1	LSA25 ZH1 A2	1	0,17
32A	13A	2	1	LSA32 ZH1 A2	1	0,17
45A	20A	2	1	LSA38 ZH1 A2	1	0,17
29A	10A	2	1	LSA16 ZH1 A2+2	1	0,22
36A	11,5A	2	1	LSA25 ZH1 A2+2	1	0,22
50A	13A	2	1	LSA32 ZH1 A2+2	1	0,22
50A	20A	2	1	LSA38 ZH1 A2+2	1	0,22
16A	16A	2	2	LSA16 ZH1 A4	1	0,21
25A	25A	2	2	LSA25 ZH1 A4	1	0,21
32A	32A	2	2	LSA32 ZH1 A4	1	0,21
45A	38A	2	2	LSA38 ZH1 A4	1	0,21
16A	16A	4	1	LSA16 ZH1 A4O	1	0,23
25A	25A	4	1	LSA25 ZH1 A4O	1	0,23
32A	32A	4	1	LSA32 ZH1 A4O	1	0,23
45A	38A	4	1	LSA38 ZH1 A4O	1	0,23
16A	16A	4	1	LSA16 ZH1 A4U	1	0,23
25A	25A	4	1	LSA25 ZH1 A4U	1	0,23
32A	32A	4	1	LSA32 ZH1 A4U	1	0,23
45A	38A	4	1	LSA38 ZH1 A4U	1	0,23
16A	10A	2	3	LSMO16 ZH1 A6	1	0,50
25A	11,5A	2	3	LSMO25 ZH1 A6	1	0,50
32A	13A	2	3	LSMO32 ZH1 A6	1	0,50
45A	20A	2	3	LSMO38 ZH1 A6	1	0,50
16A	10A	2	4	LSMO16 ZH1 A8	1	0,52
25A	11,5A	2	4	LSMO25 ZH1 A8	1	0,52
32A	13A	2	4	LSMO32 ZH1 A8	1	0,52
45A	20A	2	4	LSMO38 ZH1 A8	1	0,52

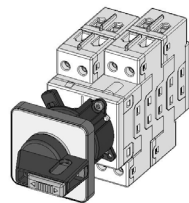

Mini DC-Isolators for Single Hole Mounting, Ø16mm, without Plate, IP66, Type 4X

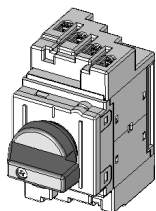

16A	10A	2	1	LSA16 Z16 A2	1	0,15
25A	11,5A	2	1	LSA25 Z16 A2	1	0,15
32A	13A	2	1	LSA32 Z16 A2	1	0,15
45A	20A	2	1	LSA38 Z16 A2	1	0,15
29A	10A	2	1	LSA16 Z16 A2+2	1	0,19
36A	11,5A	2	1	LSA25 Z16 A2+2	1	0,19
50A	13A	2	1	LSA32 Z16 A2+2	1	0,19
50A	20A	2	1	LSA38 Z16 A2+2	1	0,19
16A	16A	2	2	LSA16 Z16 A4	1	0,18
25A	25A	2	2	LSA25 Z16 A4	1	0,18
32A	32A	2	2	LSA32 Z16 A4	1	0,18
45A	38A	2	2	LSA38 Z16 A4	1	0,18
16A	16A	4	1	LSA16 Z16 A4O	1	0,19
25A	25A	4	1	LSA25 Z16 A4O	1	0,19
32A	32A	4	1	LSA32 Z16 A4O	1	0,19
45A	38A	4	1	LSA38 Z16 A4O	1	0,19
16A	16A	4	1	LSA16 Z16 A4U	1	0,19
25A	25A	4	1	LSA25 Z16 A4U	1	0,19
32A	32A	4	1	LSA32 Z16 A4U	1	0,19
45A	38A	4	1	LSA38 Z16 A4U	1	0,19
16A	10A	2	3	LSMO16 Z16 A6	1	0,45
25A	11,5A	2	3	LSMO25 Z16 A6	1	0,45
32A	13A	2	3	LSMO32 Z16 A6	1	0,45
45A	20A	2	3	LSMO38 Z16 A6	1	0,45
16A	10A	2	4	LSMO16 Z16 A8	1	0,47
25A	11,5A	2	4	LSMO25 Z16 A8	1	0,47
32A	13A	2	4	LSMO32 Z16 A8	1	0,47
45A	20A	2	4	LSMO38 Z16 A8	1	0,47

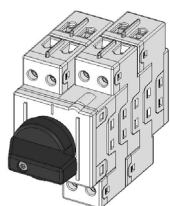

Lockable Mini DC-Isolators for Single Hole Mounting, Ø16mm, Plate 48, IP66, Type 4X

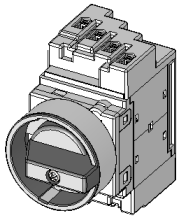

DC-PV1 (=DC21B)		Poles in Series	Number of Strings	Type	Pack pcs.	Weight kg/pce.
600V	1000V					
16A	10A	2	1	LSA16 Z16H448 A2	1	0,19
25A	11,5A	2	1	LSA25 Z16H448 A2	1	0,19
32A	13A	2	1	LSA32 Z16H448 A2	1	0,19
45A	20A	2	1	LSA38 Z16H448 A2	1	0,19
29A	10A	2	1	LSA16 Z16H448 A2+2	1	0,25
36A	11,5A	2	1	LSA25 Z16H448 A2+2	1	0,25
50A	13A	2	1	LSA32 Z16H448 A2+2	1	0,25
50A	20A	2	1	LSA38 Z16H448 A2+2	1	0,25
16A	16A	2	2	LSA16 Z16H448 A4	1	0,24
25A	25A	2	2	LSA25 Z16H448 A4	1	0,24
32A	32A	2	2	LSA32 Z16H448 A4	1	0,24
45A	38A	2	2	LSA38 Z16H448 A4	1	0,24
16A	16A	4	1	LSA16 Z16H448 A4O	1	0,26
25A	25A	4	1	LSA25 Z16H448 A4O	1	0,26
32A	32A	4	1	LSA32 Z16H448 A4O	1	0,26
45A	38A	4	1	LSA38 Z16H448 A4O	1	0,26
16A	16A	4	1	LSA16 Z16H448 A4U	1	0,26
25A	25A	4	1	LSA25 Z16H448 A4U	1	0,26
32A	32A	4	1	LSA32 Z16H448 A4U	1	0,26
45A	38A	4	1	LSA38 Z16H448 A4U	1	0,26
16A	10A	2	3	LSMO16 Z16H448 A6	1	0,51
25A	11,5A	2	3	LSMO25 Z16H448 A6	1	0,51
32A	13A	2	3	LSMO32 Z16H448 A6	1	0,51
45A	20A	2	3	LSMO38 Z16H448 A6	1	0,51
16A	10A	2	4	LSMO16 Z16H448 A8	1	0,53
25A	11,5A	2	4	LSMO25 Z16H448 A8	1	0,53
32A	13A	2	4	LSMO32 Z16H448 A8	1	0,53
45A	20A	2	4	LSMO38 Z16H448 A8	1	0,53

Mini DC-Isolators for Base Mounting, w. Door Clutch, Single Hole, Plate 64, IP66, Type 4X

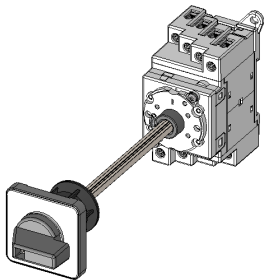

16A	10A	2	1	LSA16 VZV A2	1	0,20
25A	11,5A	2	1	LSA25 VZV A2	1	0,20
32A	13A	2	1	LSA32 VZV A2	1	0,20
45A	20A	2	1	LSA38 VZV A2	1	0,20
29A	10A	2	1	LSA16 VZV A2+2	1	0,26
36A	11,5A	2	1	LSA25 VZV A2+2	1	0,26
50A	13A	2	1	LSA32 VZV A2+2	1	0,26
50A	20A	2	1	LSA38 VZV A2+2	1	0,26
16A	16A	2	2	LSA16 VZV A4	1	0,24
25A	25A	2	2	LSA25 VZV A4	1	0,24
32A	32A	2	2	LSA32 VZV A4	1	0,24
45A	38A	2	2	LSA38 VZV A4	1	0,24
16A	16A	2	1	LSA16 VZV A4O	1	0,26
25A	25A	2	1	LSA25 VZV A4O	1	0,26
32A	32A	2	1	LSA32 VZV A4O	1	0,26
45A	38A	2	1	LSA38 VZV A4O	1	0,26
16A	16A	2	1	LSA16 VZV A4U	1	0,26
25A	25A	2	1	LSA25 VZV A4U	1	0,26
32A	32A	2	1	LSA32 VZV A4U	1	0,26
45A	38A	2	1	LSA38 VZV A4U	1	0,26

Lockable Mini DC-Isolators for Base Mounting, w. Door Clutch, Single Hole, Plate 64, IP66, Type 4X

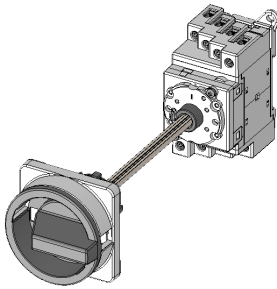

DC-PV1 (=DC21B)		Poles in Series	Number of Strings	Type	Pack pcs.	weight kg/pce.
600V	1000V					
16A	10A	2	1	LSA16 VZVH4 A2	1	0,21
25A	11,5A	2	1	LSA25 VZVH4 A2	1	0,21
32A	13A	2	1	LSA32 VZVH4 A2	1	0,21
45A	20A	2	1	LSA38 VZVH4 A2	1	0,21
29A	10A	2	1	LSA16 VZVH4 A2+2	1	0,27
36A	11,5A	2	1	LSA25 VZVH4 A2+2	1	0,27
50A	13A	2	1	LSA32 VZVH4 A2+2	1	0,27
50A	20A	2	1	LSA38 VZVH4 A2+2	1	0,27
16A	16A	2	2	LSA16 VZVH4 A4	1	0,25
25A	25A	2	2	LSA25 VZVH4 A4	1	0,25
32A	32A	2	2	LSA32 VZVH4 A4	1	0,25
45A	38A	2	2	LSA38 VZVH4 A4	1	0,25
16A	16A	4	1	LSA16 VZVH4 A4O	1	0,27
25A	25A	4	1	LSA25 VZVH4 A4O	1	0,27
32A	32A	4	1	LSA32 VZVH4 A4O	1	0,27
45A	38A	4	1	LSA38 VZVH4 A4O	1	0,27
16A	16A	4	1	LSA16 VZVH4 A4U	1	0,27
25A	25A	4	1	LSA25 VZVH4 A4U	1	0,27
32A	32A	4	1	LSA32 VZVH4 A4U	1	0,27
45A	38A	4	1	LSA38 VZVH4 A4U	1	0,27

Mini DC-Isolators for Distribution Boards, IP40, Open Type

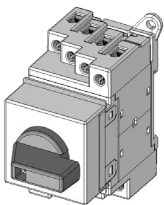

16A	10A	2	1	LSA16 SMA A2	1	0,18
25A	11,5A	2	1	LSA25 SMA A2	1	0,18
32A	13A	2	1	LSA32 SMA A2	1	0,18
45A	20A	2	1	LSA38 SMA A2	1	0,18
29A	10A	2	1	LSA16 SMA A2+2	1	0,22
36A	11,5A	2	1	LSA25 SMA A2+2	1	0,22
50A	13A	2	1	LSA32 SMA A2+2	1	0,22
50A	20A	2	1	LSA38 SMA A2+2	1	0,22
16A	16A	2	2	LSA16 SMA A4	1	0,20
25A	25A	2	2	LSA25 SMA A4	1	0,20
32A	32A	2	2	LSA32 SMA A4	1	0,20
45A	38A	2	2	LSA38 SMA A4	1	0,20
16A	16A	4	1	LSA16 SMA A4O	1	0,22
25A	25A	4	1	LSA25 SMA A4O	1	0,22
32A	32A	4	1	LSA32 SMA A4O	1	0,22
45A	38A	4	1	LSA38 SMA A4O	1	0,22
16A	16A	4	1	LSA16 SMA A4U	1	0,22
25A	25A	4	1	LSA25 SMA A4U	1	0,22
32A	32A	4	1	LSA32 SMA A4U	1	0,22
45A	38A	4	1	LSA38 SMA A4U	1	0,22

Lockable Mini DC-Isolators for Distribution Boards, IP40, Open Type

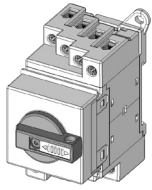

DC-PV1 (=DC21B)		Poles in Series	Number of Strings	Type	Pack pcs.	Weight kg/pce.
600V	1000V					
16A	10A	2	1	LSA16 SMAH1N A2	1	0,18
25A	11,5A	2	1	LSA25 SMAH1N A2	1	0,18
32A	13A	2	1	LSA32 SMAH1N A2	1	0,18
45A	20A	2	1	LSA38 SMAH1N A2	1	0,18
29A	10A	2	1	LSA16 SMAH1N A2+2	1	0,22
36A	11,5A	2	1	LSA25 SMAH1N A2+2	1	0,22
50A	13A	2	1	LSA32 SMAH1N A2+2	1	0,22
50A	20A	2	1	LSA38 SMAH1N A2+2	1	0,22
16A	16A	2	2	LSA16 SMAH1N A4	1	0,20
25A	25A	2	2	LSA25 SMAH1N A4	1	0,20
32A	32A	2	2	LSA32 SMAH1N A4	1	0,20
45A	38A	2	2	LSA38 SMAH1N A4	1	0,20
16A	16A	4	1	LSA16 SMAH1N A4O	1	0,22
25A	25A	4	1	LSA25 SMAH1N A4O	1	0,22
32A	32A	4	1	LSA32 SMAH1N A4O	1	0,22
45A	38A	4	1	LSA38 SMAH1N A4O	1	0,22
16A	16A	4	1	LSA16 SMAH1N A4U	1	0,22
25A	25A	4	1	LSA25 SMAH1N A4U	1	0,22
32A	32A	4	1	LSA32 SMAH1N A4U	1	0,22
45A	38A	4	1	LSA38 SMAH1N A4U	1	0,22

Mini DC-Isolators in Plastic Enclosure, IP67, Type 4X

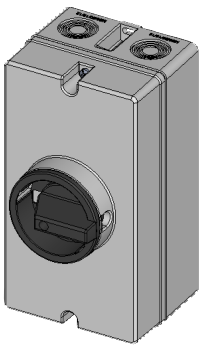

16A	10A	2	1	LSA16 PFLH4 A2	1	0,42
25A	11,5A	2	1	LSA25 PFLH4 A2	1	0,42
32A	13A	2	1	LSA32 PFLH4 A2	1	0,42
45A	20A	2	1	LSA38 PFLH4 A2	1	0,42
29A	10A	2	1	LSA16 PFLH4 A2+2	1	0,50
36A	11,5A	2	1	LSA25 PFLH4 A2+2	1	0,50
50A	13A	2	1	LSA32 PFLH4 A2+2	1	0,50
50A	20A	2	1	LSA38 PFLH4 A2+2	1	0,50
16A	16A	2	2	LSA16 PFLH4 A4	1	0,49
25A	25A	2	2	LSA25 PFLH4 A4	1	0,49
32A	32A	2	2	LSA32 PFLH4 A4	1	0,49
45A	38A	2	2	LSA38 PFLH4 A4	1	0,49
16A	16A	4	1	LSA16 PFLH4 A4O	1	0,51
25A	25A	4	1	LSA25 PFLH4 A4O	1	0,51
32A	32A	4	1	LSA32 PFLH4 A4O	1	0,51
45A	38A	4	1	LSA38 PFLH4 A4O	1	0,51
16A	16A	4	1	LSA16 PFLH4 A4U	1	0,51
25A	25A	4	1	LSA25 PFLH4 A4U	1	0,51
32A	32A	4	1	LSA32 PFLH4 A4U	1	0,51
45A	38A	4	1	LSA38 PFLH4 A4U	1	0,51

Changeover Isolators for Panel Mounting, 4 holes, Plate 64, IP66, Type 3R

DC-PV1 (=DC21B)		AC21B	Poles in Series	Type	Pack pcs.	Weight kg/pce.
600V	1000V	440V				
16A	16A	16A	4	LSA16 E U4 ¹⁾	1	0,40
25A	25A	25A	4	LSA25 E U4 ¹⁾	1	0,40
32A	32A	32A	4	LSA32 E U4 ¹⁾	1	0,40
45A	38A	45A	4	LSA38 E U4 ¹⁾	1	0,40
16A	16A	16A	4	LSA16 E U4ACDC ²⁾	1	0,40
25A	25A	25A	4	LSA25 E U4ACDC ²⁾	1	0,40
32A	32A	32A	4	LSA32 E U4ACDC ²⁾	1	0,40
45A	38A	45A	4	LSA38 E U4ACDC ²⁾	1	0,40
16A	16A	-	4	LSA16 E U4DC ³⁾	1	0,48
25A	25A	-	4	LSA25 E U4DC ³⁾	1	0,48
32A	32A	-	4	LSA32 E U4DC ³⁾	1	0,48
45A	38A	-	4	LSA38 E U4DC ³⁾	1	0,48

Changeover Isolators for Panel Mounting, 4 holes, lockable, Plate 64, IP66, Type 3R

16A	16A	16A	4	LSA16 EH4 U4 ¹⁾	1	0,43
25A	25A	25A	4	LSA25 EH4 U4 ¹⁾	1	0,43
32A	32A	32A	4	LSA32 EH4 U4 ¹⁾	1	0,43
45A	38A	45A	4	LSA38 EH4 U4 ¹⁾	1	0,43
16A	16A	16A	4	LSA16 EH4 U4ACDC ²⁾	1	0,43
25A	25A	25A	4	LSA25 EH4 U4ACDC ²⁾	1	0,43
32A	32A	32A	4	LSA32 EH4 U4ACDC ²⁾	1	0,43
45A	38A	45A	4	LSA38 EH4 U4ACDC ²⁾	1	0,43
16A	16A	-	4	LSA16 EH4 U4DC ³⁾	1	0,51
25A	25A	-	4	LSA25 EH4 U4DC ³⁾	1	0,51
32A	32A	-	4	LSA32 EH4 U4DC ³⁾	1	0,51
45A	38A	-	4	LSA38 EH4 U4DC ³⁾	1	0,51

Changeover Isolators for Panel Mounting, 2 holes, Plate 64, IP66, Type 3R

16A	16A	16A	4	LSA16 E2 U4 ¹⁾	1	0,40
25A	25A	25A	4	LSA25 E2 U4 ¹⁾	1	0,40
32A	32A	32A	4	LSA32 E2 U4 ¹⁾	1	0,40
45A	38A	45A	4	LSA38 E2 U4 ¹⁾	1	0,40
16A	16A	16A	4	LSA16 E2 U4ACDC ²⁾	1	0,40
25A	25A	25A	4	LSA25 E2 U4ACDC ²⁾	1	0,40
32A	32A	32A	4	LSA32 E2 U4ACDC ²⁾	1	0,40
45A	38A	45A	4	LSA38 E2 U4ACDC ²⁾	1	0,40
16A	16A	-	4	LSA16 E2 U4DC ³⁾	1	0,48
25A	25A	-	4	LSA25 E2 U4DC ³⁾	1	0,48
32A	32A	-	4	LSA32 E2 U4DC ³⁾	1	0,48
45A	38A	-	4	LSA38 E2 U4DC ³⁾	1	0,48

Changeover Isolators for Panel Mounting, lockable, 2 holes, Plate 64, IP66, Type 3R

16A	16A	16A	4	LSA16 E2H1 U4 ¹⁾	1	0,41
25A	25A	25A	4	LSA25 E2H1 U4 ¹⁾	1	0,41
32A	32A	32A	4	LSA32 E2H1 U4 ¹⁾	1	0,41
45A	38A	45A	4	LSA38 E2H1 U4 ¹⁾	1	0,41
16A	16A	16A	4	LSA16 E2H1 U4ACDC ²⁾	1	0,41
25A	25A	25A	4	LSA25 E2H1 U4ACDC ²⁾	1	0,41
32A	32A	32A	4	LSA32 E2H1 U4ACDC ²⁾	1	0,41
45A	38A	45A	4	LSA38 E2H1 U4ACDC ²⁾	1	0,41
16A	16A	-	4	LSA16 E2H1 U4DC ³⁾	1	0,49
25A	25A	-	4	LSA25 E2H1 U4DC ³⁾	1	0,49
32A	32A	-	4	LSA32 E2H1 U4DC ³⁾	1	0,49
45A	38A	-	4	LSA38 E2H1 U4DC ³⁾	1	0,49

1) For all applications, jumpers not included

2) Changeover Isolators AC/DC, 2 jumpers for DC side are enclosed

3) Changeover Isolators for DC, prewired

Changeover Isolators for Base Mounting, w. Door Clutch, Single Hole, Plate 64, IP66, Type 4X

DC-PV1 (=DC21B)		AC21B	Poles	Type	Pack	Weight
600V	1000V	440V	in Series		pcs.	kg/pce.
16A	16A	16A	4	LSA16 VZV U4 ¹⁾	1	0,45
25A	25A	25A	4	LSA25 VZV U4 ¹⁾	1	0,45
32A	32A	32A	4	LSA32 VZV U4 ¹⁾	1	0,45
45A	38A	45A	4	LSA38 VZV U4 ¹⁾	1	0,45
16A	16A	16A	4	LSA16 VZV U4ACDC ²⁾	1	0,45
25A	25A	25A	4	LSA25 VZV U4ACDC ²⁾	1	0,45
32A	32A	32A	4	LSA32 VZV U4ACDC ²⁾	1	0,45
45A	38A	45A	4	LSA38 VZV U4ACDC ²⁾	1	0,45
16A	16A	-	4	LSA16 VZV U4DC ³⁾	1	0,50
25A	25A	-	4	LSA25 VZV U4DC ³⁾	1	0,50
32A	32A	-	4	LSA32 VZV U4DC ³⁾	1	0,50
45A	38A	-	4	LSA38 VZV U4DC ³⁾	1	0,50

Changeover Isolators for Base Mounting, lockable, w. Door Clutch, Single Hole, Plate 64, IP66, Type 4X

16A	16A	16A	4	LSA16 VZVH4 U4 ¹⁾	1	0,45
25A	25A	25A	4	LSA25 VZVH4 U4 ¹⁾	1	0,45
32A	32A	32A	4	LSA32 VZVH4 U4 ¹⁾	1	0,45
45A	38A	45A	4	LSA38 VZVH4 U4 ¹⁾	1	0,45
16A	16A	16A	4	LSA16 VZVH4 U4ACDC ²⁾	1	0,45
25A	25A	25A	4	LSA25 VZVH4 U4ACDC ²⁾	1	0,45
32A	32A	32A	4	LSA32 VZVH4 U4ACDC ²⁾	1	0,45
45A	38A	45A	4	LSA38 VZVH4 U4ACDC ²⁾	1	0,45
16A	16A	-	4	LSA16 VZVH4 U4DC ³⁾	1	0,50
25A	25A	-	4	LSA25 VZVH4 U4DC ³⁾	1	0,50
32A	32A	-	4	LSA32 VZVH4 U4DC ³⁾	1	0,50
45A	38A	-	4	LSA38 VZVH4 U4DC ³⁾	1	0,50

Changeover Isolators for Distribution Boards, lockable, lower handle, IP40, Open Type

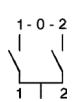
16A	16A	16A	4	LSA16 SMAH1N U4 ¹⁾	1	0,40
25A	25A	25A	4	LSA25 SMAH1N U4 ¹⁾	1	0,40
32A	32A	32A	4	LSA32 SMAH1N U4 ¹⁾	1	0,40
45A	38A	45A	4	LSA38 SMAH1N U4 ¹⁾	1	0,40
16A	16A	16A	4	LSA16 SMAH1N U4ACDC ²⁾	1	0,40
25A	25A	25A	4	LSA25 SMAH1N U4ACDC ²⁾	1	0,40
32A	32A	32A	4	LSA32 SMAH1N U4ACDC ²⁾	1	0,40
45A	38A	45A	4	LSA38 SMAH1N U4ACDC ²⁾	1	0,40
 16A	16A	-	4	LSA16 SMAH1N U4DC ³⁾	1	0,45
25A	25A	-	4	LSA25 SMAH1N U4DC ³⁾	1	0,45
32A	32A	-	4	LSA32 SMAH1N U4DC ³⁾	1	0,45
45A	38A	-	4	LSA38 SMAH1N U4DC ³⁾	1	0,45

1) For all applications, jumpers not included

2) Changeover Isolators AC/DC, 2 jumpers for DC side are enclosed

3) Changeover Isolators for DC, prewired

Technical Data

Kind of current	Category		Typical applications	Test conditions for the number of on-load operating cycles (normal service)						Test conditions for making and breaking capacities (operation in fault case)					
				Make			Break			Make			Break		
				I/le	U/Ue	L/R	Ic/le	Ur/Ue	L/R	I/le	U/Ue	L/R	Ic/le	Ur/Ue	L/R
Direct current	DC21A frequent operation	DC21B infrequent operation	Switching of resistive loads including moderate overloads	1	1	1ms	1	1	1ms	1,5	1,05	1ms	1,5	1,05	1ms
	DC22A frequent operation	DC22B infrequent operation	Switching of mixed resistive a.induct. loads incl. moderate overloads (shunt motors)	1	1	2ms	1	1	2ms	4	1,05	2,5ms	4	1,05	2,5ms
	DC-PV1		Switching of single PV string(s) without reverse- and overcurrents.	1	1	1ms	1	1	1ms	1,5	1,05	1ms	1,5	1,05	1ms
	DC-PV2		Switching of several PV strings with reverse- and overcurrents.	1	1	1ms	1	1	1ms	4	1,05	1ms	4	1,05	1ms

Data according to IEC 60947-3, VDE 0660, GB14048.3 (CCC China)



Main contacts	Type	LSA16 LSM016	LSA25 LSM025	LSA32 LSM032	LSA38 LSM038		
Rated thermal current I_{th}	A	16	25	32	45		
Rated insulation voltage U_i ¹⁾	V	1000	1000	1000	1000		
Rated insulation voltage U_i ²⁾	V	1500	1500	1500	1500		
Distance of contacts (per pole)	mm	8	8	8	8		
Rated operational current I_e							
AC21B	A2, A4	U_e max. 440V	A	16	25	32	45
	A2 +2	U_e max. 440V	A	29	45	50	50

1) Suitable at overvoltage category I to III, pollution degree 3 (standard-industry): $U_{imp} = 8kV$.

2) Suitable at overvoltage category I to III, pollution degree 2 (min. IP55): $U_{imp} = 8kV$.

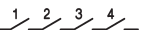
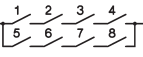

Technical Data

Data acc. to IEC 60947-3, VDE 0660

Main Contacts		Type	LSA16	LSA25	LSA32	LSA38	
Rated operational current I_e DC-PV1	1 pole	300V	A	16	23	27	-
		400V	A	14	22	25	-
	A1 	500V	A	10	17	20	-
		600V	A	7	12	15	-
		700V	A	5	6	7,5	-
		800V	A	3	4	5	-
		900V	A	3	3	4	-
		1000V	A	2	2	3	-
		2 poles in series A2 	500V	A	16	25	32
	600V		A	16	25	32	45
	700V		A	16	25	32	36
	800V		A	16	20	23	30
	900V		A	16	17	20	25
	1000V		A	10	11,5	13	20
	1100V		A	8	10	-	-
	1200V		A	7	8,5	10	10
	1300V		A	6	7	-	-
	1400V		A	5	6	-	-
	1500V		A	3	5	6	6
2 poles in series + 2 poles parallel A2+2 	500V		A	29	45	50	50
	600V	A	29	36	50	50	
	700V	A	22	27	32	36	
	800V	A	17	20	23	30	
	900V	A	16	17	20	25	
	1000V	A	10	11,5	13	20	
	1100V	A	8	10	-	-	
	1200V	A	7	8,5	10	10	
	1300V	A	6	7	-	-	
	1400V	A	5	6	-	-	
	1500V	A	3	5	6	6	
	4 poles in series A4 	500V	A	16	25	32	45
600V		A	16	25	32	45	
700V		A	16	25	32	45	
800V		A	16	25	32	45	
900V		A	16	25	32	45	
1000V		A	16	25	32	38	
1100V		A	16	25	-	-	
1200V		A	16	25	32	32	
1300V		A	16	25	-	-	
1400V		A	16	25	-	-	
1500V		A	16	25	32	32	
		Type	LSMO16	LSMO25	LSMO32	LSMO38	
4 poles in series + 2 poles parallel A4+2 		500V	A	29	45	50	50
	600V	A	29	45	50	50	
	700V	A	29	45	50	50	
	800V	A	29	45	50	50	
	900V	A	29	45	50	50	
	1000V	A	29	45	50	50	
	1100V	A	29	-	-	-	
	1200V	A	29	33	50	50	
	1300V	A	29	-	-	-	
	1400V	A	29	-	-	-	
1500V	A	20	26	32	32		

Technical Data

Data acc. to IEC 60947-3, VDE 0660

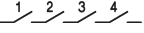
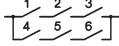
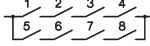
Main Contacts		Type	LSA16	LSA25	LSA32	LSA38	
Rated operational current I_e DC-PV2	300V	A	16	23	27	45	
	400V	A	14	18	20	33	
1 pole A1 	500V	A	10	12	14	15	
	600V	A	5	6	8	9	
	700V	A	1,5	2	3	6	
	800V	A	1,5	2	3	5	
	900V	A	1	1,5	2	4	
	1000V	A	1	1,5	2	3	
	<hr/>						
	2 poles in series A2 	500V	A	16	25	32	45
600V		A	14	21	27	45	
700V		A	13	19	22	40	
800V		A	12	15	17	30	
900V		A	8	10	12	20	
1000V		A	4	5	6	13	
1100V		A	3	4	-	-	
1200V		A	2	3	4	6	
1300V		A	1,5	2	-	-	
1400V		A	1	2	-	-	
1500V		A	1	1,5	2	3	
<hr/>							
2 poles in series + 2 poles parallel A2+2 	500V	A	25	39	50	50	
	600V	A	20	32	35	50	
	700V	A	13	19	22	40	
	800V	A	12	15	17	30	
	900V	A	8	10	12	20	
	1000V	A	4	5	6	13	
	1100V	A	3	4	-	-	
	1200V	A	2	3	4	6	
	1300V	A	1,5	2	-	-	
	1400V	A	1	2	-	-	
	1500V	A	1	1,5	2	3	
<hr/>							
4 poles in series A4 	500V	A	16	25	32	45	
	600V	A	16	25	32	45	
	700V	A	16	25	32	45	
	800V	A	16	25	32	45	
	900V	A	16	25	32	45	
	1000V	A	16	25	32	45	
	1100V	A	16	25	-	-	
	1200V	A	13,5	21	27	42	
	1300V	A	12	19	-	-	
	1400V	A	10,5	16	-	-	
	1500V	A	9	14	18	28	
<hr/>							
		Type	LSMO16	LSMO25	LSMO32	LSMO38	
3 poles in series + 2 poles parallel A3+2 	500V	A	28	45	50	50	
	600V	A	22	38	44	48	
	700V	A	20	30	34	35	
	800V	A	18	26	29	31	
	900V	A	16	22	24	24	
	1000V	A	15	18	20	20	
	1100V	A	-	-	-	-	
	1200V	A	11	13,5	15	15	
	1300V	A	-	-	-	-	
	1400V	A	-	-	-	-	
	1500V	A	4	6,5	8	8	
<hr/>							
4 poles in series + 2 poles parallel A4+2 	500V	A	29	45	50	50	
	600V	A	29	45	50	50	
	700V	A	25	40	50	50	
	800V	A	21	35	45	50	
	900V	A	18	30	37	50	
	1000V	A	16	25	32	50	
	1100V	A	-	-	-	-	
	1200V	A	13,5	21	27	27	
	1300V	A	-	-	-	-	
	1400V	A	-	-	-	-	
	1500V	A	9	14	18	18	





Technical Data

Data according to IEC 60947-3, VDE 0660



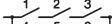
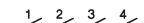

Main contacts		Type	LSA16 LSMO16	LSA25 LSAMO25	LSA32 LSMO32	LSA38 LSMO38
Rated conditional short-circuit current		kA _{eff}	5	5	5	5
Max. fuse size	gL (gG)	A	40	63	80	80
Mechanical life		x10 ³	10	10	10	10
Rated short-time withstand current (1s)	I _{cw} A2, A4 A2+2	A	800	900	1000	1000
		A	1300	1500	1700	1700
Short circuit making capacity	I _{cm} A2, A4 A2+2	A	800	900	1000	1000
		A	1300	1500	1700	1700
Maximum cable cross sections (incl. jumper LSAV-B1)						
solid or stranded		mm ²	0,5 - 10	0,5 - 10	0,5 - 10	0,5 - 10
flexible		mm ²	0,5 - 6	0,5 - 6	0,5 - 6	0,5 - 6
flexible (+ multicore cable end)		mm ²	0,5 - 6	0,5 - 6	0,5 - 6	0,5 - 6
Size of terminal screw			M4 Pz1	M4 Pz1	M4 Pz1	M4 Pz1
Tightening torque		Nm	1,4	1,4	1,4	1,4
2 cables per clamp without jumper LSAV-B1						
solid or stranded		mm ²	10+(1,5-2,5) / 6+(1,5-6) / 4+(1,5-4)			
flexible		mm ²	(0,5-6)+(0,5-6)			
stranded		AWG	6+(20-14) / 8+(20-12) / 10+(20-10) 12+(20-12)			
solid		AWG	10+(16-10) / 12+(16-12) 14+(16-14)			
Maximum ambient temperature						
Operation		open	°C			
		enclosed	°C			
Storage			°C			
Power loss per switch at I _e max.						
A2		(A)/W	(16)/1	(25)/2,3	(32)/3,7	(45)/7,1
A4		(A)/W	(16)/2	(25)/4,6	(32)/7,4	(45)/14,2
A2+2		(A)/W	(29)/1,5	(45)/3,7	(50)/4,4	(50)/4,4
Contact resistance per pole		mΩ	1,75	1,75	1,75	1,75

Technical Data

Data according to UL508I  File E359344, Category no.: NMSJ, and UL60947-1  File E332938, Category no.: NRNT2,

Main contacts			Type	LSA16	LSA25	LSA32	LSA38
Ampere-Rating	"General use"	DC					
1 pole	350V		A	4	5	6	6
	500V		A	4	5	6	6
	600V		A	4	5	6	6
2 poles in series	350V		A	16	25	32	38
A2	500V		A	16	25	32	38
	600V		A	16	25	32	38
2 poles in series + 2 poles parallel	350V		A	29	45	50	50
A2+2	500V		A	29	38	43	45
600V		A	21	27	33	36	
							
4 poles in series	350V		A	16	25	32	38
A4	500V		A	16	25	32	38
600V		A	16	25	32	36	
							
			Type	LSMO16	LSMO25	LSMO32	LSMO38
3 poles in series + 2 poles parallel	350V		A	16	25	50	50
A3+2	500V		A	16	25	50	50
600V		A	16	25	45	45	
							
4 poles in series + 2 poles parallel	350V		A	16	25	50	50
A4+2	500V		A	16	25	50	50
600V		A	16	25	50	50	
							
Fuse size (RK5) Industrial Control Switch	5kA / 600V		A	40	60	80	80
Maximum cable cross sections (incl. jumper LSAV-B1)							
solid or stranded		AWG		16 - 10	16 - 10	16 - 10	16 - 10
flexible		AWG		20 - 6	20 - 6	20 - 6	20 - 6
flexible (+ multicore cable end)		AWG		20 - 6	20 - 6	20 - 6	20 - 6
Size of terminal screw				M4 Pz1	M4 Pz1	M4 Pz1	M4 Pz1
Tightening torque		lb.inch		12,4	12,4	12,4	12,4
Protection class of terminals ¹⁾				IP20	IP20	IP20	IP20

Approvals

Country	USA, UL508I	US, Canada UL508	Europe	China CCC	CB-certificates	EAC
						
Type						
LSA16/LSMO16	o	o	/	o	x	o
LSA25/LSMO25	o	o	/	o	x	o
LSA32/LSMO32	o	o	/	o	x	o
LSA38/LSMO38	o	o	/	o	x	o

o In standard version approved

/ No testing required CE

x pending

- not provided for testing till now

1) Protection degree of the terminals with connected insulated conductor.

Technical Data

Example for maximum currents according to ambient temperatures and cable cross sections:

Switch **open** LSA(O)16..., 2 contacts in series (A2)

Switch **open** LSA(O)16 ..., 2 contacts in series + 2 parallel (A2+2)

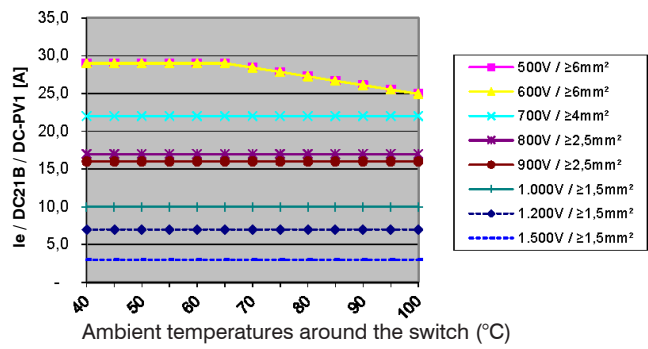
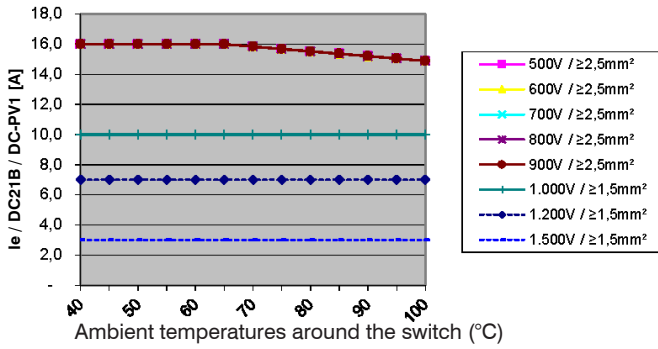

Switch **enclosed** LSA(O)16 PFL..., 2 contacts in series (A2)

Switch **enclosed** LS16(M)O PFL..., 2 contacts in series + 2 parallel (A2+2)

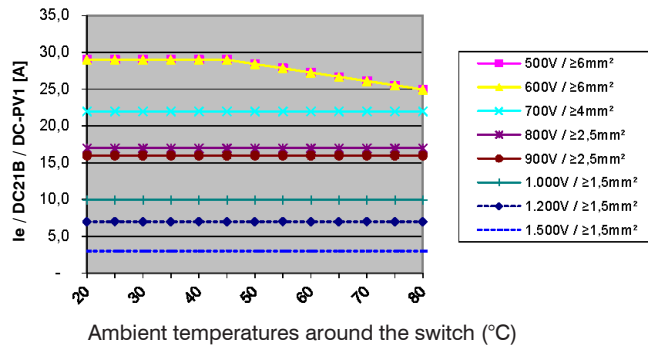
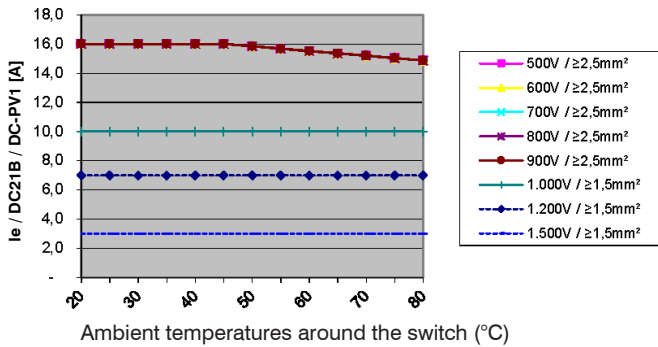

All data about maximum currents according to ambient temperatures and cable cross sections for switches LSA(O)16.. to LSA(O)38.. (open or enclosed) please find under www.benedict.at (Button "Customers").

Dimensions:

**LSA16 E.. up to LSA38 E..
..A2**

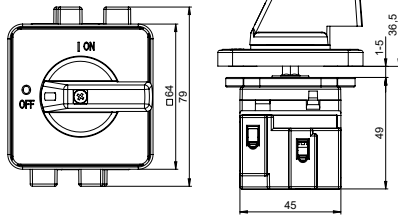

Mounting hole

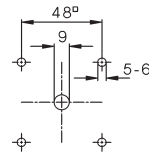

**LSA16 E.. up to LSA38 E..
..A2+2, ..A4**

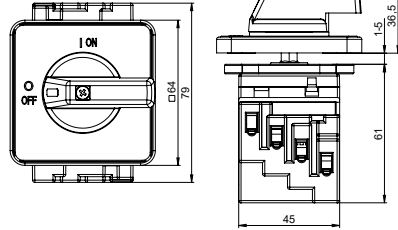

Mounting hole

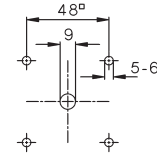

**LSA16 EH4.. up to LSA38 EH4..
..A2**

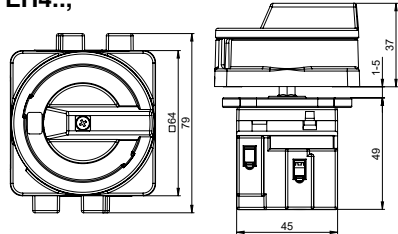

Mounting hole

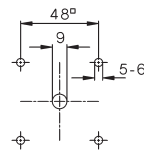

**LSA16 EH4.. up to LSA38 EH4..
..A2+2, ..A4**

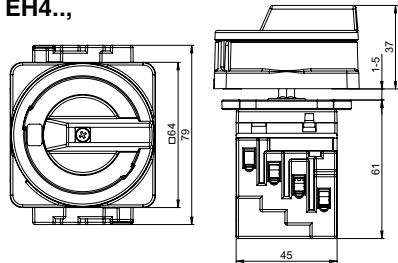

Mounting hole

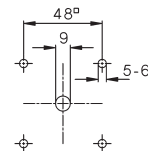

**LSA16 E2.. up to LSA38 E2..
..A2**

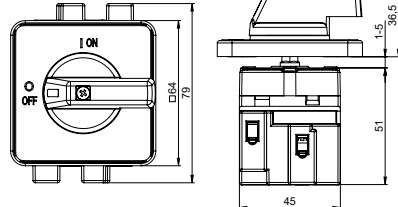

Mounting hole

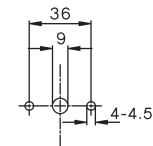

**LSA16 E2.. up to LSA38 E2..
..A2+2, ..A4**

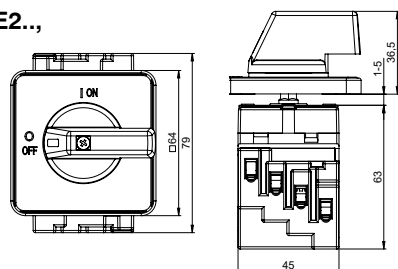

Mounting hole

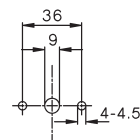

Dimensions:

**LSA16 E2H1.. up to LSA38 E2H1...
..A2**

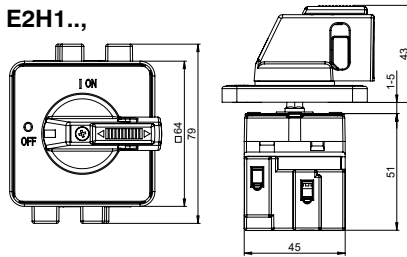

Mounting hole

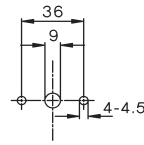

**LSA16 E2H1.. up to LSA38 E2H1...
..A2+2, ..A4**

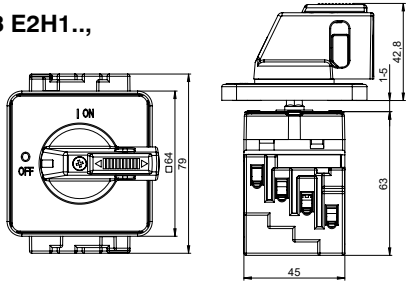

Mounting hole

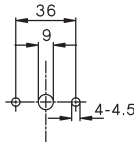

**LSA16 Z.. up to LSA38 Z...
..A2**

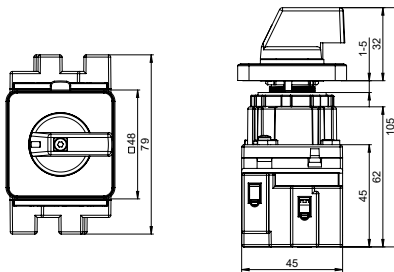

**LSA16 Z.. up to LSA38 Z...
..A2+2, ..A4**

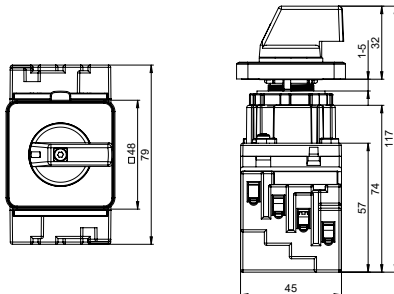

Detailed view - Mounting hole for LSA16 Z(O).. up to LSA38 Z(O)..

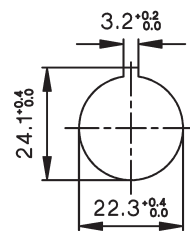

**LSA16 ZO.. up to LSA38 ZO...
..A2**

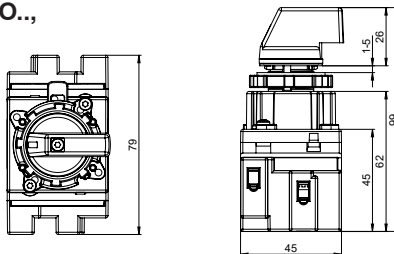

**LSA16 ZO.. up to LSA38 ZO...
..A2+2, ..A4**

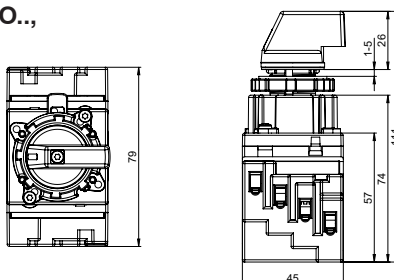

Dimensions:

LSA16 ZH1.. up to LSA38 ZH1...,
..A2

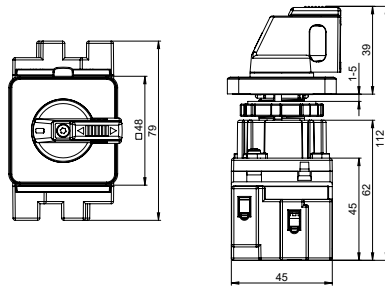

Detailed view - Mounting hole for LSA16 ZH1.. up to LSA38 ZH1..

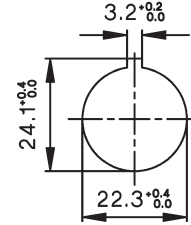

LSA16 ZH1.. up to LSA38 ZH1...,
..A2+2, ..A4

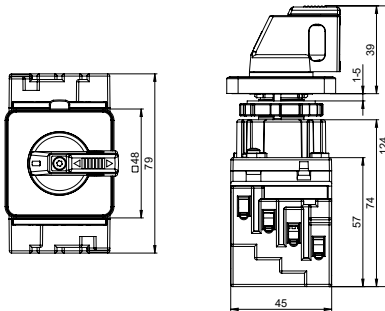

LSA16 Z16.. up to LSA38 Z16...,
..A2

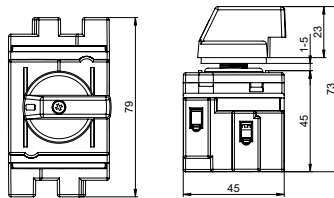

Mounting hole

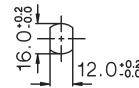

LSA16 Z16.. up to LSA38 Z16...,
..A2+2, ..A4

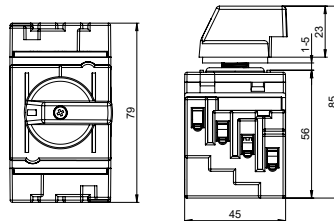

Mounting hole

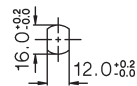

LSA16 ZH448.. up to LSA38 Z16H448...,
..A2

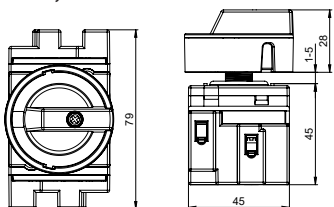

Mounting hole

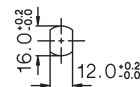

LSA16 ZH448.. up to LSA38 ZH448...,
..A2+2, ..A4

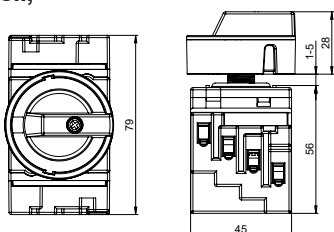

Mounting hole

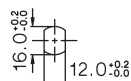

Dimensions:

**LSA16 VZV.. up to LSA38 VZV..
..A2**

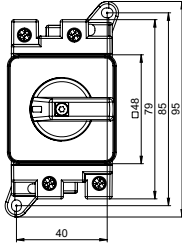

$X_{max} = 182, L = 155,5$
 $(X_{min} = 59,5)$
 $L = X - 26,5 \pm 3$

**LSA16 VZV.. up to LSA38 VZV..
..A2+2, ..A4**

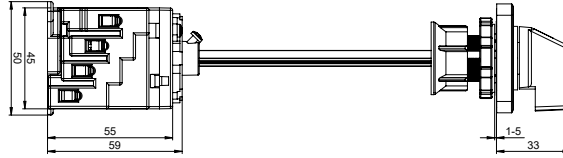
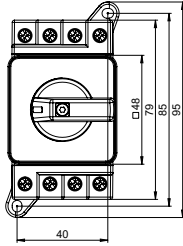

$X_{max} = 194, L = 155,5$
 $(X_{min} = 71,5)$
 $L = X - 38,5 \pm 3$

**LSA16 VZVH4.. up to LSA38 VZVH4..
..A2**

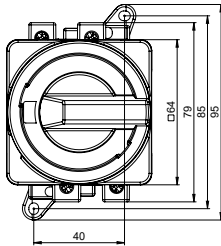

$X_{max} = 182, L = 155,5$
 $(X_{min} = 59,5)$
 $L = X - 26,5 \pm 3$

**LSA16 VZVH4.. up to LSA38 VZVH4..
..A2+2, ..A4**

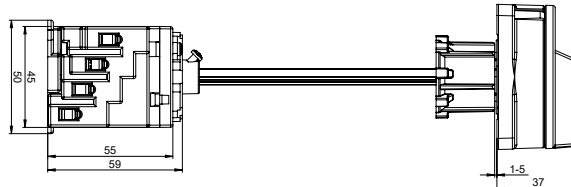
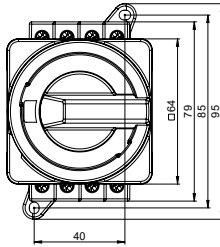

$X_{max} = 194, L = 155,5$
 $(X_{min} = 71,5)$
 $L = X - 38,5 \pm 3$

Detailed view - Mounting
hole for LSA16 VZV(H)..
up to LSA38 VZV(H)..

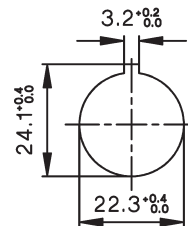

Dimensions:

LSA16 SMA.. up to LSA38 SMA...
..A2

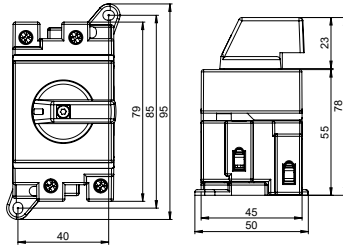

LSA16 SMA.. up to LSA38 SMA...
..A2+2, ..A4

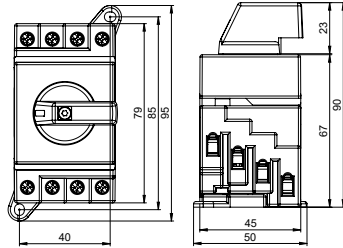

LSA16 SMAH1N.. up to LSA38 SMAH1N...
..A2

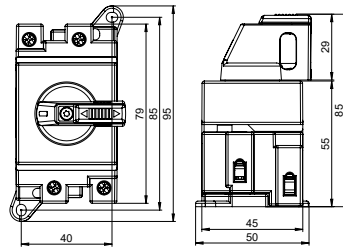

LSA16 SMAH1N.. up to LSA38 SMAH1N...
..A2+2, ..A4

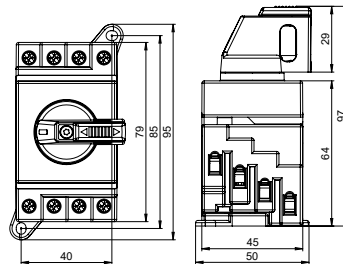

Dimensions:

**LSA16 PFLH4.. up to LSA38 PFLH4..,
..A2, ..A2+2, ..A4**

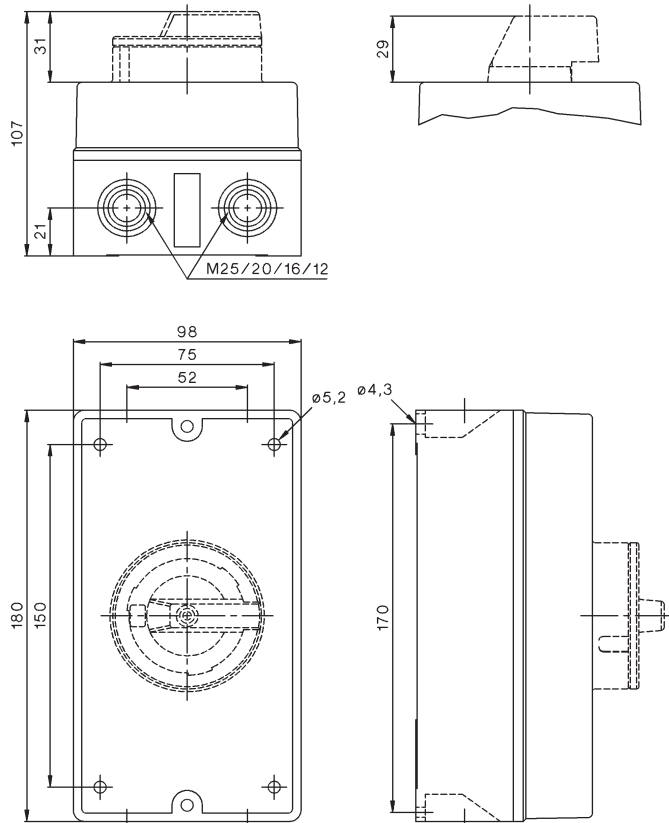

**LSMO16 E.. up to LSMO38 E..,
..A6**

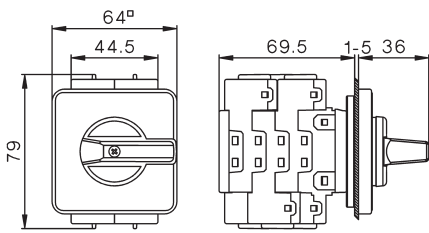

**LSMO16 E.. up to LSMO38 E..,
..A8**

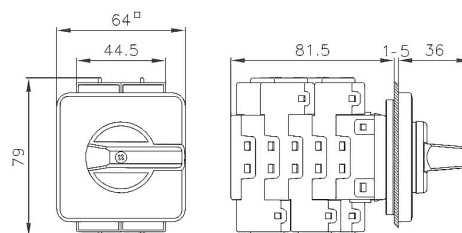

**LSMO16 Z.. up to LSMO38 Z..,
..A6**

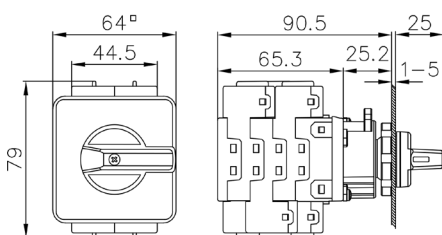

**LSMO16 Z.. up to LSMO38 Z..,
..A8**

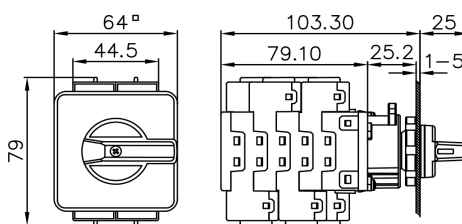

Dimensions:

LSA16 E U4 up to LSA38 E U4,
LSA16 E U4ACDC up to LSA38 E U4ACDC

LSA16 E U4DC up to LSA38 E U4DC

LSA16 EH4 U4 up to LSA38 EH4 U4,
LSA16 EH4 U4ACDC up to LSA38 EH4 U4ACDC

LSA16 EH4 U4DC up to LSA38 EH4 U4DC

LSA16 E2 U4 up to LSA38 E U4,
LSA16 E2 U4ACDC up to LSA38 E U4ACDC

LSA16 E2 U4DC up to LSA38 E U4DC

LSA16 E2H4 U4 up to LSA38 EH4 U4,
LSA16 E2H4 U4ACDC up to LSA38 EH4 U4ACDC

LSA16 E2H4 U4DC up to LSA38 EH4 U4DC

Dimensions:

LSA16 VZV U4 up to LSA38 VZV U4,
LSA16 VZV U4ACDC up to LSA38 VZV U4ACDC

LSA16 VZV U4DC up to LSA38 VZV U4DC

LSA16 VZVH4 U4 up to LSA38 EH4 U4,
LSA16 VZVH4 U4ACDC up to LSA38 EH4 U4ACDC

LSA16 VZVH4 U4DC up to LSA38 VZVH4 U4DC

Dimensions:

LSA16 SMAH1N U4 up to LSA38 SMAH1N U4,
LSA16 SMAH1N U4ACDC up to LSA38 SMAH1N U4ACDC

LSA16 SMAH1N U4DC up to LSA38 SMAH1N U4DC

Changeover Isolators - Applications:

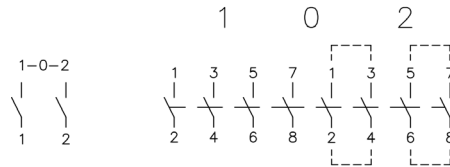
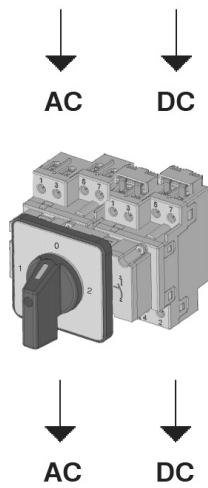

LSA.. U4ACDC (2 pcs. jumpers attached)

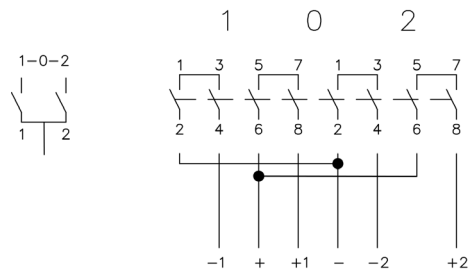
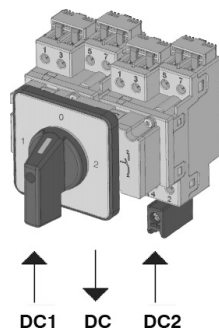

LSA.. U4DC (prewired)

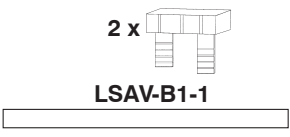
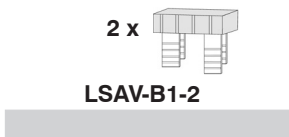
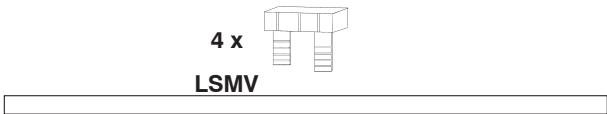

Isolated jumpers LSAV-.. for Series and Parallel switching of contacts:

Type	LSA16	LSA25	LSA32	LSA38
A4O A4U A4B	 <p>2 x LSAV-B1-1</p>		 <p>2 x LSAV-B1-2</p>	
Type	LSMO16	LSMO25	LSMO32	LSMO38
A4+2	 <p>4 x LSMV</p>			
	 <p>2 x LSMOV</p>			

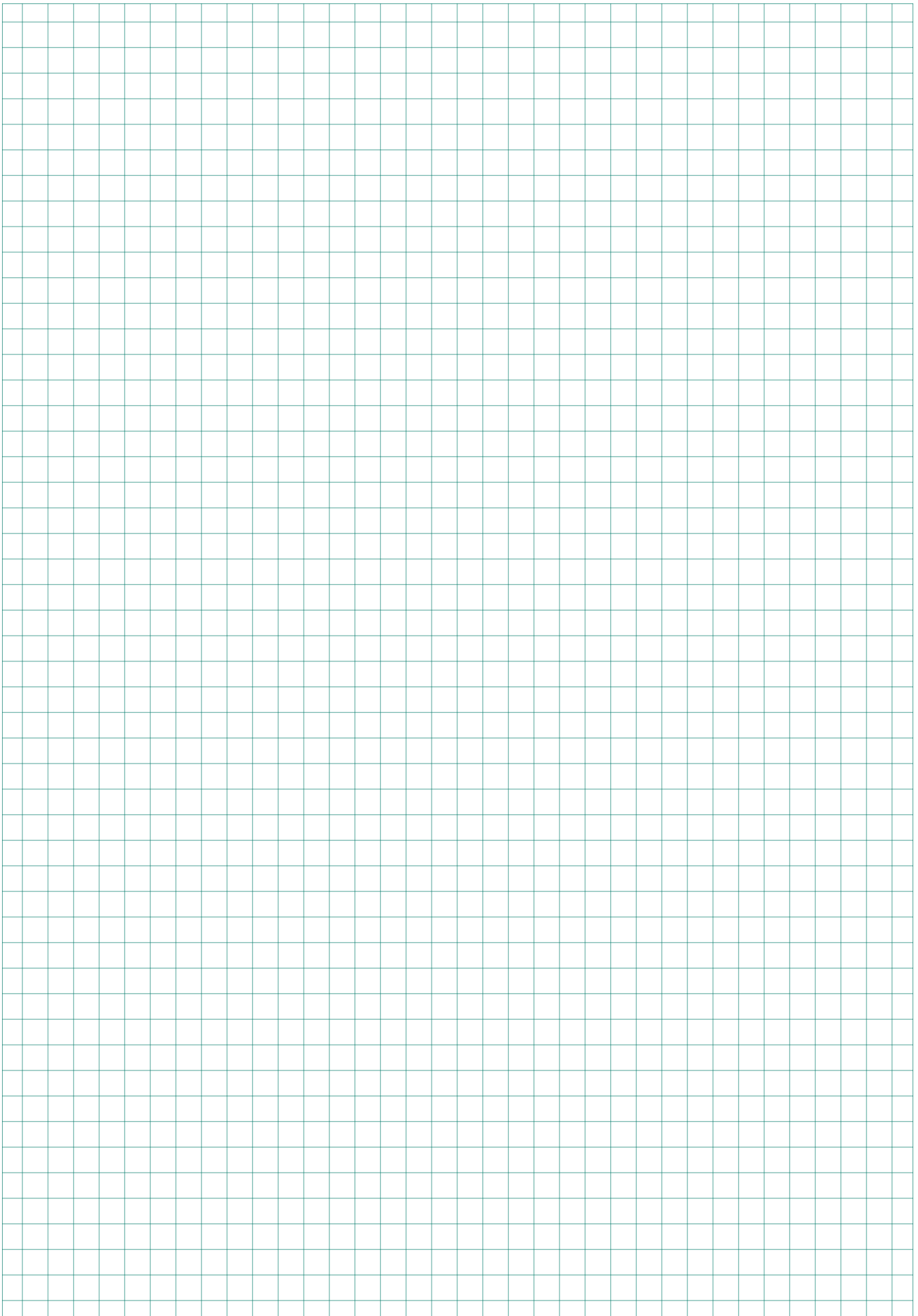



Quality made in 

D1080E241



Lieblgasse 7, A-1220 Wien
Telefon: + 43 1 251 51 - 0
Fax: + 43 1 251 51 - 89
e-mail: sales@benedict.at
www.benedict.at

