







Index	Page
	Circuit-Breakers M4 for motor protection 166
	Auxiliary contacts Signalling switch Auxiliary releases 167
	Insulated 3-pole busbar system Terminal block 168
	DIN-rail adapters Busbar adapters Link modules 169
	Technical Data 171
	Characteristics Installation Accessories 176 178
	Dimensions 182

Circuit Breakers M4 for Motor Control

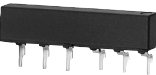
Rated Current I_n A	Suitable for motors ¹⁾ 3~400V kW	Setting range Thermal Overload Release A	Instantaneous Short Circuit Release A	Short Circuit Breaking Capacity at 3~400V kA (I_{cu})	Type	Pack pcs.	Weight approx. kg/pc.
-----------------------------	---	--	--	---	------	--------------	-----------------------------

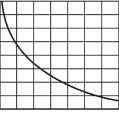
Circuit Breaker M4-32T-..



switch type

0,16	-	0,10 – 0,16	2,1	100	M4-32T-0,16	1	0,32
0,25	0,06	0,16 – 0,25	3,3	100	M4-32T-0,25	1	0,32
0,4	0,09	0,25 – 0,4	5,2	100	M4-32T-0,4	1	0,32
0,63	0,18	0,4 – 0,63	8,2	100	M4-32T-0,63	1	0,32
1	0,25	0,63 – 1	13	100	M4-32T-1	1	0,32
1,6	0,55	1 – 1,6	20,8	100	M4-32T-1,6	1	0,32
2,5	0,75	1,6 – 2,5	32,5	100	M4-32T-2,5	1	0,32
4	1,5	2,5 – 4	52	100	M4-32T-4	1	0,32
6	2,2	4 – 6	78	100	M4-32T-6	1	0,32
8	3	5 – 8	104	100	M4-32T-8	1	0,32
10	4	6 – 10	130	50	M4-32T-10	1	0,32
13	5,5	9 – 13	169	50	M4-32T-13	1	0,32
17	7,5	11 – 17	221	20	M4-32T-17	1	0,32
22	7,5	14 – 22	286	15	M4-32T-22	1	0,32
26	11	18 – 26	338	15	M4-32T-26	1	0,32
32	15	22 – 32	416	15	M4-32T-32	1	0,32
40	18,5	28 – 40	520	10	M4-32T-40	1	0,32

Circuit Breaker M4-32R-..



rotary type

0,16	-	0,10 – 0,16	2,1	100	M4-32R-0,16	1	0,36
0,25	0,06	0,16 – 0,25	3,3	100	M4-32R-0,25	1	0,36
0,4	0,09	0,25 – 0,4	5,2	100	M4-32R-0,4	1	0,36
0,63	0,18	0,4 – 0,63	8,2	100	M4-32R-0,63	1	0,36
1	0,25	0,63 – 1	13	100	M4-32R-1	1	0,36
1,6	0,55	1 – 1,6	20,8	100	M4-32R-1,6	1	0,36
2,5	0,75	1,6 – 2,5	32,5	100	M4-32R-2,5	1	0,36
4	1,5	2,5 – 4	52	100	M4-32R-4	1	0,36
6	2,2	4 – 6	78	100	M4-32R-6	1	0,36
8	3	5 – 8	104	100	M4-32R-8	1	0,36
10	4	6 – 10	130	100	M4-32R-10	1	0,36
13	5,5	9 – 13	169	100	M4-32R-13	1	0,36
17	7,5	11 – 17	221	50	M4-32R-17	1	0,36
22	7,5	14 – 22	286	50	M4-32R-22	1	0,36
26	11	18 – 26	338	50	M4-32R-26	1	0,36
32	15	22 – 32	416	50	M4-32R-32	1	0,36
40	18,5	28 – 40	520	40	M4-32R-40	1	0,36

Circuit Breaker M4-63R-..



rotary type

26	12,5	18 – 26	338	50	M4-63R-26	1	1,0
32	15	22 – 32	416	50	M4-63R-32	1	1,0
40	18,5	28 – 40	520	50	M4-63R-40	1	1,0
50	22	34 – 50	650	50	M4-63R-50	1	1,0
63	30	45 – 63	819	50	M4-63R-63	1	1,0

Circuit Breaker M4-100R-..



rotary type

63	30	45 – 63	819	50	M4-100R-63	1	2,2
75	37	55 – 75	975	50	M4-100R-75	1	2,2
90	45	70 – 90	1170	50	M4-100R-90	1	2,2
100	-	80 – 100	1300	50	M4-100R-100	1	2,2

1) Approximate values of standard motors

Accessories

	Contacts		Rated Operational Current			Type	Pack pcs.	Weight approx. kgpc
	NO	NC	AC15 24V A	AC1 240V A	AC1 240V A			

Transverse Auxiliary Contact Block, max. 1 pc. per circuit-breaker ¹⁾



1	1		3	2	5	M4 HQ11	1	0,02
2	-		3	2	5	M4 HQ20	1	0,02
-	2		3	2	5	M4 HQ02	1	0,02

Auxiliary Contact Block for left hand side mounting, 1 or 2 pcs. per circuit-breaker ¹⁾



1	1		6	4	10	M4 HS11	1	0,03
2	-		6	4	10	M4 HS20	1	0,03
-	2		6	4	10	M4 HS02	1	0,03

Alarm Switch (any tripping) for left hand side mounting, max. 1 pc. per circuit-breaker ¹⁾



1	1	for M4-32T, -32R	6	4	10	M4 MA11	1	0,04
1	1	for M4-63R, -100R	6	4	10	M4 MA11 63	1	0,04

Alarm Switch (short circuit) for left hand side mounting, max. 1 pc. per circuit-breaker ¹⁾



1	1		6	4	10	M4 M11	1	0,04
---	---	--	---	---	----	--------	---	------

Operates in case of short circuit accidents that is over 20 times of the rated current of the circuit breaker.

Undervoltage Releases for right hand side mounting, max. 1 pc. per circuit-breaker ¹⁾

Trips the circuit-breaker when the voltage is interrupted. Prevents the motor from being restarted accidentally when the voltage is restored, suitable for EMERGENCY STOP acc. to IEC 60204



24V 50Hz, 28V 60Hz		M4 U24	1	0,11
110-127V 50Hz, 120V 60Hz		M4 U110	1	0,11
220-230V 50Hz, 240-260V 60Hz		M4 U230	1	0,11
240V 50Hz, 277V 60Hz		M4 U240	1	0,11
380-400V 50Hz, 440-460V 60Hz		M4 U400	1	0,11
415-440V 50Hz, 460-480V 60Hz		M4 U415	1	0,11

Shunt Releases for right hand side mounting, max. 1 pc. per circuit-breaker ¹⁾

Trips the circuit-breaker when the release coil energized.
100% ON max. 5sec. ON



20-24V 50Hz, 28V 60Hz	20-70V 50/60Hz DC	M4 A24	1	0,12
75-127V 50Hz, 120V 60Hz	75-190V 50/60Hz DC	M4 A110	1	0,12
190-230V 50Hz, 240-260V 60Hz	190-330V 50/60Hz DC	M4 A230	1	0,12
200-240V 50Hz, 277V 60Hz	200-330V 50/60Hz DC	M4 A240	1	0,12
300-400V 50Hz, 440-460V 60Hz	300-500V 50/60Hz DC	M4 A400	1	0,12
330-440V 50Hz, 460-480V 60Hz	330-500V 50/60Hz DC	M4 A415	1	0,12



Enclosure for circuit breaker M4 32R protection degree IP65



Plastic enclose with rotary operating mechanism black-grey lockable, with N- and PE-terminal space for 1 transverse and side aux. contact + release	M4 32R PFH4	1	0,53
Enclose with rotary operating mechanism yellow - red, lockable with N- and PE-terminal space for 1 transverse and side aux. contact + release	M4 32R PFHN4	1	0,53



1) Number and position see page 179

Accessories and Busbars

			for circuit- breaker	Type	Pack pcs.	Weight approx. kg/pc.
	Scale cover sealable	for covering the current setting scale	M4-32...100	M4 K	10	0,003
	Spade terminal block	up to 600V acc.UL 489	M4-32R	M4 32R E		on request

Door-coupling rotary mechanisms IP65

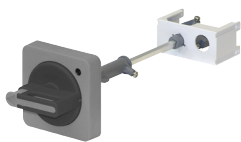



The door locking device prevents accidental opening of the cubicle door in the ON position of the circuit-breaker. The OFF position can be locked with up to 3 padlocks.

	Door-coupling rotary mechanism black	extension shaft 115mm	M4-32R	M4 32R EH1 115	1	0,1
		extension shaft 315mm	M4-32R	M4 32R EH1 315	1	0,2
		extension shaft 115mm	M4-63R	M4 63R EH1 115	1	0,1
		extension shaft 315mm	M4-63R	M4 63R EH1 315	1	0,2
		extension shaft 115mm	M4-100R	M4 100R EH1 115	1	0,1
		extension shaft 315mm	M4-100R	M4 100R EH1 315	1	0,2
	Emergency-Stop Door-coupling rotary mechanism; red/yellow	extension shaft 115mm	M4-32R	M4 32R EHN1 115	1	0,1
		extension shaft 315mm	M4-32R	M4 32R EHN1 315	1	0,2
		extension shaft 115mm	M4-63R	M4 63R EHN1 115	1	0,1
		extension shaft 315mm	M4-63R	M4 63R EHN1 315	1	0,2
		extension shaft 115mm	M4-100R	M4 100R EHN1 115	1	0,1
		extension shaft 315mm	M4-100R	M4 100R EHN1 315	1	0,2

			Protection degree	Type	Pack pcs.	Weight kg/pc.
--	--	--	----------------------	------	--------------	------------------

Insulated 3-phase busbar system

For feeding several modular circuit-breakers M4-32. on standard mounting rails, insulated
Rated operational voltage max. 690 V, rated current 63 A, with **spade connection**, modular spacing 45mm (54mm on request)

	3-phase busbars	for 2 circuit-breakers	IP20	M4 32 S2	1	0,03
		for 3 circuit-breakers	IP10	M4 32 S3	1	0,05
		for 4 circuit-breakers	IP10	M4 32 S4	1	0,07
		for 5 circuit-breakers	IP10	M4 32 S5	1	0,10
	Line side terminal 3-pole, connection from above	Conductor cross-section solid or stranded 6-25mm ² with end sleeve 4-16mm ²	IP10	M4 32 SE	1	0,04
	Cover for tags	Touch guard for empty spaces		M4 32 SF	1	0,003
	Cover for tags	Touch guard for empty spaces		M4 32 SFV	1	0,003

For feeding several modular circuit-breakers M4-63. on standard mounting rails, insulated
Rated operational voltage max. 690 V, rated current 108 A, with **pin connection**, modular spacing 55mm

	3-phase busbars	for 2 circuit-breakers	IP20	M4 63 S2	1	0,15
--	-----------------	------------------------	------	----------	---	------

Mounting Parts for Fuseless Load Feeders

	Type	Pack pcs.	Weight approx. kg/pc.
DIN-rail adapters with DIN-rail for contactor			
	for M4-32.. DIN-rails moveable for easy mounting and replacing can be connected on one 35 mm DIN-rail (high 15mm) or two 35 mm-DIN-rails (125mm distance) suitable for contactors K1-..., K(G)3-10 to K(G)3-40	M4 32 HU1	1 0,1
	Adapter, for M4-63.. can be connected on two 35 mm DIN-rails (125mm distance) or one 75 mm DIN-rail, or screw mounting suitable for contactors K(G)3-24 to K(G)3-40, K3-50 to K3-74	M4 63 HU1	1 0,2
	Adapter, for M4-100.. can be connected on two 35 mm DIN-rails (125mm distance) or one 75 mm DIN-rail, or screw mounting suitable for contactors K3-50 to K3-74	M4 100 HU1	1 0,2

Busbar adapters for 60-mm-system, 3 copper busbars acc. to DIN 46433			
	for M4-32 up to 25A, 690V 45mm width, 182mm long bar width: 12 und 15mm bar thickness: 5 and 10mm	M4 32 SA60	1 0,18

Link modules, for mechanical and electrical connection between circuit-breaker and contactor				
	for M4-32.. with contactors K1-..	max. 32A	M4 32 VK1	1 0,015
	for M4-32.. with contactors K3-10 to K3-22	max. 32A	M4 32 VK3	1 0,02
	for M4-32.. with contactors KG3-10 to KG3-22	max. 32A	M4 32 VKG3	1 0,02

Link modules, for electrical connection between circuit-breaker and contactor				
	for M4-63R. with contactors K3-24 to K3-74	max. 63A	M4 63 VD	1 0,02
	for M4-63R. with contactors KG3-24 to KG3-40	max. 63A	M4 63 VDG	1 0,02
	for M4-100R. with contactors K3-50 to K3-74	max. 100A	M4 100 VD	1 0,02

Components for Fuseless Load Feeders, DIN-Rail Mounting

Type of coordination "1" 3x415V 10kA ¹⁾



Motor 3~400V kW	Setting range A	Circuit-breaker page 166 Type	Link module Type	Contactor ²⁾ 220-230V 50Hz Type	DIN-rail adapter Type
-	0,10 – 0,16	M4-32T-0,16	M4 32 VK1	K1-09D10 230	-
0,06	0,16 – 0,25	M4-32T-0,25	M4 32 VK1	K1-09D10 230	-
0,09	0,25 – 0,4	M4-32T-0,4	M4 32 VK1	K1-09D10 230	-
0,18	0,4 – 0,63	M4-32T-0,63	M4 32 VK1	K1-09D10 230	-
0,25	0,63 – 1	M4-32T-1	M4 32 VK1	K1-09D10 230	-
0,55	1,0 – 1,6	M4-32T-1,6	M4 32 VK1	K1-09D10 230	-
0,75	1,6 – 2,5	M4-32T-2,5	M4 32 VK1	K1-09D10 230	-
1,5	2,5 – 4	M4-32T-4	M4 32 VK1	K1-09D10 230	-
2,2	4 – 6	M4-32T-6	M4 32 VK1	K1-09D10 230	-
3	5 – 8	M4-32T-8	M4 32 VK1	K1-09D10 230	-
4	6 – 10	M4-32T-10	M4 32 VK1	K1-09D10 230	-
5,5	9 – 13	M4-32T-13	M4 32 VK1	K1-12D10 230	-
7,5	11 – 17	M4-32T-17	M4 32 VK3	K3-18ND10 230EUR	-
7,5	14 – 22	M4-32T-22	M4 32 VK3	K3-22ND10 230EUR	-
11	18 – 26	M4-32T-26	M4 32 VK3	K3-22ND10 230EUR	-
15	22 – 32	M4-32T-32	M4 32 VD	K3-32A00 230	M4 32 HU1
18,5	28 – 40	M4-32T-40	M4 32 VD	K3-40A00 230	M4 32 HU1
-	0,10 – 0,16	M4-32R-0,16	M4 32 VK3	K3-10ND10 230EUR	-
0,06	0,16 – 0,25	M4-32R-0,25	M4 32 VK3	K3-10ND10 230EUR	-
0,09	0,25 – 0,4	M4-32R-0,4	M4 32 VK3	K3-10ND10 230EUR	-
0,18	0,4 – 0,63	M4-32R-0,63	M4 32 VK3	K3-10ND10 230EUR	-
0,25	0,63 – 1	M4-32R-1	M4 32 VK3	K3-10ND10 230EUR	-
0,55	1,0 – 1,6	M4-32R-1,6	M4 32 VK3	K3-10ND10 230EUR	-
0,75	1,6 – 2,5	M4-32R-2,5	M4 32 VK3	K3-10ND10 230EUR	-
1,5	2,5 – 4	M4-32R-4	M4 32 VK3	K3-10ND10 230EUR	-
2,2	4 – 6	M4-32R-6	M4 32 VK3	K3-10ND10 230EUR	-
3	5 – 8	M4-32R-8	M4 32 VK3	K3-10ND10 230EUR	-
4	6 – 10	M4-32R-10	M4 32 VK3	K3-10ND10 230EUR	-
5,5	9 – 13	M4-32R-13	M4 32 VK3	K3-14ND10 230EUR	-
7,5	11 – 17	M4-32R-17	M4 32 VK3	K3-18ND10 230EUR	-
7,5	14 – 22	M4-32R-22	M4 32 VK3	K3-22ND10 230EUR	-
11	18 – 26	M4-32R-26	M4 32 VK3	K3-22ND10 230EUR	-
15	22 – 32	M4-32R-32	M4 32 VD	K3-32A00 230	M4 32 HU1
18,5	28 – 40	M4-32R-40	M4 32 VD	K3-40A00 230	M4 32 HU1
12,5	18 – 26	M4-63R-26	M4 63 VD	K3-32A00 230	M4 63 HU1
15	22 – 32	M4-63R-32	M4 63 VD	K3-32A00 230	M4 63 HU1
18,5	28 – 40	M4-63R-40	M4 63 VD	K3-40A00 230	M4 63 HU1
22	34 – 50	M4-63R-50	M4 63 VD	K3-50A00 230	M4 63 HU1
30	45 – 63	M4-63R-63	M4 63 VD	K3-62A00 230	M4 63 HU1
30	45 – 63	M4-100R-63	M4 100 VD	K3-62A00 230	M4 100 HU1
37	55 – 75	M4-100R-75	M4 100 VD	K3-74A00 230	M4 100 HU1
45	70 – 90	M4-100R-90	-	K3-90A00 230	-
-	80 – 100	M4-100R-100	-	K3-115A00 230	-

1) Other conditions on request

2) Contactors K1.. 220-230V 50Hz, Contactors K3.. 220-240V 50Hz, further technical data see Catalog D677..

Technical Data according to IEC/EN 60947-1, 60947-2, 60947-4-1 and VDE 0660

This table shows the rated ultimate short-circuit breaking capacity I_{cu} and the rated service short-circuit breaking capacity I_{cs} of the M4 circuit-breakers with different operational voltages as a function of the rated current I_n of the circuit-breakers. The circuit-breakers can be fed at the top or bottom supply terminals without any reduction of the rated data.

If the short-circuit current exceeds the rated short-circuit breaking capacity of the circuit-breaker specified in the tables at the installation point, a back-up fuse is to be used. The maximum rated current for the back-up fuse is specified in the tables. These fuses are only suitable for the short-circuit-currents as indicated on the fuses.

Circuit-breaker	Rated-current I_n	up to AC 240V ²⁾			up to AC 400V ²⁾ up to AC 415V ³⁾			up to AC 440V ²⁾ up to AC 460V ³⁾			up to AC 500V ²⁾ up to AC 525V ³⁾			up to AC 690V ²⁾		
		I_{cu}	I_{cs}	max. fuse ¹⁾ (gL/gG)	I_{cu}	I_{cs}	max. fuse ¹⁾ (gL/gG)	I_{cu}	I_{cs}	max. fuse ¹⁾ (gL/gG)	I_{cu}	I_{cs}	max. fuse ¹⁾ (gL/gG)	I_{cu}	I_{cs}	max. fuse ¹⁾ (gL/gG)
Type	A	kA	kA	A	kA	kA	A	kA	kA	A	kA	kA	A	kA	kA	A
M4-32T	0,16 ... 0,63	100	100	--	100	100	--	100	100	--	100	100	--	100	100	--
	1	100	100	--	100	100	--	100	100	--	100	100	--	100	100	--
	1,6	100	100	--	100	100	--	100	100	--	100	100	--	3	3	20
	2,5	100	100	--	100	100	--	100	100	--	50	38	50	3	3	35
	4	100	100	--	100	100	--	50	38	50	15	11	40	3	3	40
	6	100	100	--	100	100	--	15	11	50	10	8	50	3	3	50
	8	100	100	--	100	100	--	15	11	63	10	8	63	3	3	63
	10	100	100	--	50	38	80	15	11	63	6	5	63	3	3	63
	13	100	100	--	50	38	80	10	8	80	6	5	80	3	3	63
	17	50	38	--	20	15	100	10	8	80	6	5	80	3	3	63
	22	40	30	125	15	11	100	8	6	100	6	5	80	3	3	63
	26	40	30	125	15	11	100	8	6	100	6	5	80	3	3	63
	32	30	22	125	15	11	100	6	4	100	5	4	80	3	3	63
	40	20	15	160	10	8	125	5	3	100	4	3	80	2	2	63
M4-32R	0,16 ... 1,0	100	100	--	100	100	--	100	100	--	100	100	--	100	100	--
	1,6	100	100	--	100	100	--	100	100	--	100	100	--	100	100	--
	2,5	100	100	--	100	100	--	100	100	--	100	100	--	8	8	35
	4	100	100	--	100	100	--	100	100	--	100	100	--	8	8	40
	6	100	100	--	100	100	--	100	100	--	100	100	--	6	6	50
	8	100	100	--	100	100	--	50	38	80	50	38	63	6	6	63
	10	100	100	--	100	100	--	50	38	80	50	38	80	6	6	63
	13	100	100	--	100	100	--	50	38	80	42	32	80	6	6	63
	17	100	100	--	50	38	100	25	15	80	10	8	80	4	4	63
	22	100	100	--	50	38	125	25	15	100	10	8	80	4	4	63
26	100	100	--	50	38	125	25	15	100	10	8	80	4	4	63	
32	100	100	--	50	38	125	25	15	100	10	8	80	4	4	63	
40	100	100	--	40	30	160	15	11	125	8	6	160	3	3	80	
M4-63R	26	100	100	--	50	50	125	35	27	125	12	9	100	5	5	80
	32	100	100	--	50	50	125	35	27	125	10	8	100	5	5	80
	40	100	100	--	50	50	160	35	27	125	10	8	100	5	5	80
	50	100	100	--	50	50	160	35	27	125	10	8	100	5	5	80
	63	100	100	--	50	50	160	35	27	160	10	8	100	5	5	80
M4-100R	63	100	100	--	50	38	160	40	30	160	12	9	100	6	5	80
	75	100	100	--	50	38	160	40	30	160	8	6	125	5	4	100
	90	100	100	--	50	38	160	40	30	160	8	6	125	5	4	125
	100	100	100	--	50	38	160	40	30	160	8	6	125	5	4	125

-- No back-up fuse required

1) Back up fuse required if short-circuit current at installation point $I_{cc} > I_{cu}$



2) 10 % overvoltage

3) 5 % overvoltage

Main Circuit

Type		M4-32T	M4-32R	M4-63R	M4-100R
Number of poles		3	3	3	3
Max. rated current I_{nmax} (=max. rated operational current I_n)	A	40	40	63	100
Permissible ambient temperature					
Storage/transport	°C	-50 to +80	-50 to +80	-50 to +80	-50 to +80
Operation	°C	-20 to +60	-20 to +60	-20 to +60	-20 to +60
Storage/transport	°F	-58 to +176	-58 to +176	-58 to +176	-58 to +176
Operation	°F	-4 to +140	-4 to +140	-4 to +140	-4 to +140
Rated insulation voltage U_i	V	690 ¹⁾	690 ¹⁾	1000 ²⁾	1000 ²⁾
Rated impulse withstand voltage U_{imp}	kV	6	6	8	8
Rated operational voltage U_e	V	690	690	690	690
Rated frequency	Hz	50/60	50/60	50/60	50/60
Utilization category					
IEC 60947-2 (circuit-breaker)		A	A	A	A
IEC 60947-4-1 (motor starter)		AC3	AC3	AC3	AC3
Class	acc. to IEC 60947-4-1	10	10	10	10
Power loss P_v per circuit-breaker dependent on rated current I_n (upper setting range)	$I_n \rightarrow 0,16$ up to 1,6 A $I_n \rightarrow 2,5$ up to 26 A $I_n \rightarrow 32$ A	W W W	4,4 7,4 4	4,4 7,4 -	- - -
R per conducting path = $P/I^2 \times 3$	$I_n \rightarrow 26$ up to 63 A $I_n \rightarrow$ up to 63 A $I_n \rightarrow 75$ up to 100 A	W W W	- - -	- - -	- 21,8 17,8
Shock resistance	acc. to IEC 60068 Part 2-27	g	25	25	25
Degree of protection	acc. to IEC 60529		IP 20	IP 20	IP 20
Shock hazard protection	acc. to DIN VDE 0106 Part 100		safe against finger touch	safe against finger touch	safe against finger touch
Temperature compensation	acc. to IEC 60947-4-1	°C	-20 to +60	-20 to +60	-20 to +60
Mechanical endurance	operating cycles		100 000	100 000	50 000
Electrical endurance			100 000	100 000	25 000
Max. operating frequency per hour (motor starts)	1/h		25	25	25

Approvals

Country Type	 USA, Canada UL	 Switzerland SEV	 Europe CE	CB/CCA-Certificates
M4-32T	o	o	/	o
M4-32R	o	o	/	o
M4-63R	o	o	/	o
M4-100R	o	o	/	o
M4 H..	o	-	/	-
M4 M..	o	-	/	-
M4 U..	o	-	/	-
M4 A..	o	-	/	-





o In standard version approved / No testing required CE x In test
 - Not provided for test till now

1) Suitable at 690V for: earthed-neutral systems, overvoltage category I to IV, pollution degree 3 (standard-industry): $U_{imp} = 6kV$.

2) Suitable at 1000V for: earthed-neutral systems, overvoltage category I to IV, pollution degree 3 (standard-industry): $U_{imp} = 8kV$.

3) Data for other conditions on request.

Conductor cross-sections for main circuit

Type	Terminal type, screw type	Tightening torque		Conductor, cross-sections solid		Conductor, cross-sections stranded		Conductor, cross-sections flexible	
		Nm	lb - in	mm ²	AWG	mm ²	AWG	mm ²	AWG
M4-32T 	Pz2	0,8 - 2,5	7 - 22	1 x (1 - 10) 2 x (1 - 6)	1 x (18 - 8) 2 x (18 - 10)	1 x (1 - 6) 2 x (1 - 6)	1 x (18 - 10) 2 x (18 - 10)	1 x (1 - 6) 2 x (0,75 - 4)	1 x (18 - 10) 2 x (18 - 10)
M4-32R 	Pz2	0,8 - 2,5	7 - 22	1 x (1 - 10) 2 x (1 - 6)	1 x (18 - 8) 2 x (18 - 10)	1 x (1 - 6) 2 x (1 - 6)	1 x (18 - 10) 2 x (18 - 10)	1 x (1 - 6) 2 x (0,75 - 4)	1 x (18 - 10) 2 x (18 - 10)
M4-63R 	Pz2	3 - 4,5	26 - 39	1 x (0,75 - 35) 2 x (0,75 - 25)	1 x (18 - 2) 2 x (18 - 4)	1 x (0,75 - 35) 2 x (0,75 - 25)	1 x (18 - 2) 2 x (18 - 4)	1 x (0,75 - 25) 2 x (0,75 - 16)	1 x (18 - 4) 2 x (18 - 6)
M4-100R 	4mm hexagon socket screw	4 - 6	35 - 53	1 x (2,5 - 70) 2 x (2,5 - 50)	1 x (12 - 2/0) 2 x (12 - 1/0)	1 x (2,5 - 70) 2 x (2,5 - 50)	1 x (12 - 2/0) 2 x (12 - 1/0)	1 x (2,5 - 50) 2 x (2,5 - 35)	1 x (12 - 1/0) 2 x (10 - 2)

Auxiliary switches

Type	Rated operational voltage		Rated operational current		Rated operational voltage		Rated operational current	
	Ue		Ie/AC-15		Ue		Ie/DC-13	
	AC				DC L/R 200 ms			
Type	V	A	A	A	V	A	A	A
Front transverse auxiliary switch	M4 HQ..	24 240	3 3	5 5	24 220	1 0,1		
Lateral auxiliary switch and signalling switch	M4 HS..							
	M4 M..	24 240	6 4	10 10	24 220	2 0,25		

Type	Power consumption during pick-up		Response voltage trip	Response voltage acc. to IEC 60947-1
	VA/W	V		
Undervoltage release	M4 U..	8,5/6	3/1,2	0,7 - 0,35xUs 0,85 - 1,1xUs
Shunt release	M4 A..	8,5/6	3/1,2	0,7 - 1,1xUs

Short-circuit protection for auxiliary and control circuits	Fuse	Miniature circuit breaker	solid	flexible	AWG-wires, solid	flexible
	gL/gG	C-characteristic	mm ²	mm ²	AWG	AWG
	A	A				
Short-circuit protection for auxiliary and control circuits	16	6				
Conductor cross-sections for auxiliary and control circuits			1 x (0,5 - 2,5) 2 x (0,5 - 2,5) ¹⁾	1 x (0,5 - 4) 2 x (0,75 - 2,5)	1 x (20 - 14) 2 x (20 - 14) ¹⁾	1 x (20 - 10) 2 x (18 - 14)

1) M4 HQ.. 1 solid conductor only

Permissible ratings of devices approved for North America

Circuit breakers M4 as „Manual Motor Starter“

If used as „Manual Motor Starter“ the circuit breaker is always operated in combination with a short circuit device. For use with approbated fuses or circuit breakers according to UL489 or CSA22.2 No. 5 only. The sizes are selected according to National Electrical Code (UL), or Canadian Electrical Code (CSA).

Typ	Rated operational current le A	Max. short-circuit current			Motor load 1-phase		Motor load 3-phase				Max. rated fuse A	Max. breaker size A
		240V kA	480V kA	600V kA	115V HP	230V HP	200V HP	230V HP	460V HP	600V HP		
M4-32T	0,16 ... 0,63	100	50	10	-	-	-	-	-	-	1	15
	1	100	50	10	-	-	-	-	-	1/2	3	15
	1,6	100	50	10	-	1/10	-	-	3/4	3/4	6	15
	2,5	100	50	10	-	1/6	1/2	1/2	1	1 1/2	10	15
	4	100	50	5	1/8	1/3	3/4	3/4	2	3	15	15
	6	100	25	5	1/4	1/2	1	1 1/2	3	5	20	20
	8	100	25	5	1/3	1	2	2	5	5	30	30
	10	50	10	5	1/2	1 1/2	2	3	5	7 1/2	40	40
	13	50	10	5	1/2	2	3	3	7 1/2	10	50	50
	17	40	10	5	1	3	3	5	10	15	60	60
	22	30	10	5	1 1/2	3	5	7 1/2	15	20	80	80
	26	30	7,5	5	2	3	7 1/2	7 1/2	15	20	100	100
	32	20	7,5	5	2	5	7 1/2	10	20	30	125	125
	40	20	7,5	5	3	7 1/2	10	10	30	30	150	150
M4-32R	0,16 ... 0,63	100	50	10	-	-	-	-	-	-	1	15
	4	100	50	10	1/8	1/3	3/4	3/4	2	3	15	15
	6	100	50	10	1/4	1/2	1	1 1/2	3	5	20	20
	8	100	50	10	1/3	1	2	2	5	5	30	30
	10	100	50	10	1/2	1 1/2	2	3	5	7 1/2	40	40
	13	100	50	10	1/2	2	3	3	7 1/2	10	50	50
	17	100	30	10	1	3	3	5	10	15	60	60
	22	100	30	10	1 1/2	3	5	7 1/2	15	20	80	80
	26	100	30	10	2	3	7 1/2	7 1/2	15	20	100	100
	32	100	30	10	2	5	7 1/2	10	20	30	125	125
	40	100	30	10	3	7 1/2	10	10	30	30	150	150
M4-63R		100	50	10	2	3	7 1/2	7 1/2	15	20	100	100
	32	100	50	10	2	5	7 1/2	10	20	30	125	125
	40	100	50	10	3	7 1/2	10	10	30	30	150	150
	50	100	50	10	5	10	15	15	30	40	200	200
	63	100	50	10	5	10	20	20	40	60	250	250
M4-100R	63	100	25	10	5	10	20	20	40	60	250	250
	75	100	25	10	5	15	20	25	50	60	300	300
	90	100	25	10	7 1/2	20	25	30	60	75	350	350
	100	100	25	10	10	20	30	30	75	100	400	400

Permissible ratings of devices approved for North America

Circuit breakers M4 as „Combination Motor Controller Type E“ and "Suitable for Group Installation"

Acc to UL 508 demands a line-side 1 inch air and 2 inch creepage distance for „Combination Motor Controller Type E“ is necessary. Therefore circuit-breaker M4-32R is approved to UL 508 in combination with the Terminal block M4 32R E. Circuit-breakers M4-100 are approved to UL 508 in combination with the insulation barriers M4 100 E. According to CSA these terminal blocks can be omitted when the device is used as „Combination Motor Controller Type E“.

Type	Rated operational current I _e A	Max. short-circuit current			Motor load 1-phase		Motor load 3-phase				Max. rated fuse A	Max. breaker A
		240V kA	480V kA	600V kA	115V HP	230V HP	200V HP	230V HP	460V HP	600V HP		
M4-32R	0,16 ... 0,63	100	65	25	-	-	-	-	-	-	500	500
(+M4 32R E)	1	100	65	25	-	-	-	-	-	1/2	500	500
	1,6	100	65	25	-	1/10	-	-	3/4	3/4	500	500
	2,5	100	65	25	-	1/6	1/2	1/2	1	1 1/2	500	500
	4	100	65	25	1/8	1/3	3/4	3/4	2	3	500	500
	6	100	65	25	1/4	1/2	1	1 1/2	3	5	500	500
	8	100	65	25	1/3	1	2	2	5	5	500	500
	10	100	65	25	1/2	1 1/2	2	3	5	7 1/2	500	500
	13	100	65	25	1/2	2	3	3	7 1/2	10	500	500
	17	100	30	10	1	3	3	5	10	15	500	500
	22	100	30	10	1 1/2	3	5	7 1/2	15	20	500	500
	26	100	30	10	2	5	7 1/2	7 1/2	15	20	500	500
	32	100	30	10	2	5	7 1/2	10	20	30	500	500
	40	100	30	10	3	7 1/2	10	10	30	30	500	500
M4-63R	26	100	50	10	2	3	7 1/2	7 1/2	15	20	600	600
	32	100	50	10	2	5	7 1/2	10	20	30	600	600
	40	100	50	10	3	7 1/2	10	10	30	30	600	600
	50	100	50	10	5	10	15	15	30	40	600	600
	63	100	50	10	5	10	20	20	40	60	600	600
M4-100R	63	100	40	10	5	10	20	20	40	60	1000	1000
(+M4 100 E)	75	100	40	10	5	15	20	25	50	60	1000	1000
	90	100	40	10	7 1/2	20	25	30	60	75	1000	1000
	100	100	40	10	10	20	30	30	75	100	1000	1000

Ratings of auxiliary switches and alarm switches

	Breaking capacity		Rated operational voltage max. V AC	Rated operational current A
	AC	DC		
Lateral auxiliary M4 HS.. and signalling switch M4 M..	A600	Q300	600	10
Transversal auxiliary switch M4 HQ..	A300	R300	240	5

Description

Releases

Circuit-breakers M4 are equipped with bimetallic-based, inverse-time delayed overload releases and with instantaneous overcurrent releases (electromagnetic short-circuit releases). The overload releases can be set in accordance with the load current. The overcurrent releases are permanently set to a value 13 times the rated current and thus enable trouble-free start-up of motors. The scale cover can be sealed to prevent unauthorized adjustments to the set current.

Operating mechanisms

Circuit-breakers M4-32T are actuated via a rocker operating mechanism and circuit-breakers M4-32R, M4-63R and M4-100R via a rotary operating mechanism. An electrical signal can be output, at all Circuit-breakers, via a signalling switch to indicate that the Circuit-breaker has tripped. All operating mechanisms can be locked in the 0 position with a padlock (shackle diameter 3.5 to 4.5 mm). The M4 Circuit-breakers fulfil the isolation characteristics specified in IEC 60947-2.

Operating conditions

Circuit-breakers M4 are suitable for use in any climate. To avoid error tripping we recommend to protect the Circuit Breakers M4 against fresh and cold air (caused by air condition etc.) They are designed for operation in enclosed rooms under normal conditions (e. g. no dust, corrosive vapours or harmful gases). Suitable enclosures must be provided for installation in dusty or damp rooms. Circuit-breakers M4 can also be fed from below. In order to prevent premature tripping due to phase failure sensitivity, the three conducting paths must always be uniformly loaded. The conducting paths must be connected in series in the case of single-phase loads.

Short-circuit protection

The short-circuit releases of M4 circuit-breakers disconnect the faulty load feeder from the system in the event of a short circuit and thus prevent any further damage from being caused. Circuit-breakers with a short-circuit breaking capacity of 50 kA or 100 kA at a voltage of 400 V AC are practically short-circuit-proof at this voltage, as higher short-circuit currents are not usually encountered at the installation point. Back-up fuses are only necessary if the short-circuit current at the installation point exceeds the rated ultimate short-circuit breaking capacity of the circuit-breakers.

Motor protection

The tripping characteristics of M4 circuit-breakers are designed mainly to protect three-phase induction motors. The circuit-breakers are therefore also referred to as Manual Motor Starters. The current of the motor to be protected is set with the aid of the scale.

Line protection

M4 Circuit-breakers for motor protection are also suitable for line protection. The M4 Circuit-breakers fulfil the isolation conditions of IEC 60 947-3 as well as the additional test conditions for circuit-breakers with isolation characteristics specified in IEC 60947-2. Taking IEC 60 204-1 into consideration, they can thus be implemented as main and EMERGENCY STOP switches. Door-coupling rotary operating mechanism do not fulfil the isolation characteristics.

Tripping-Characteristics

M4-32

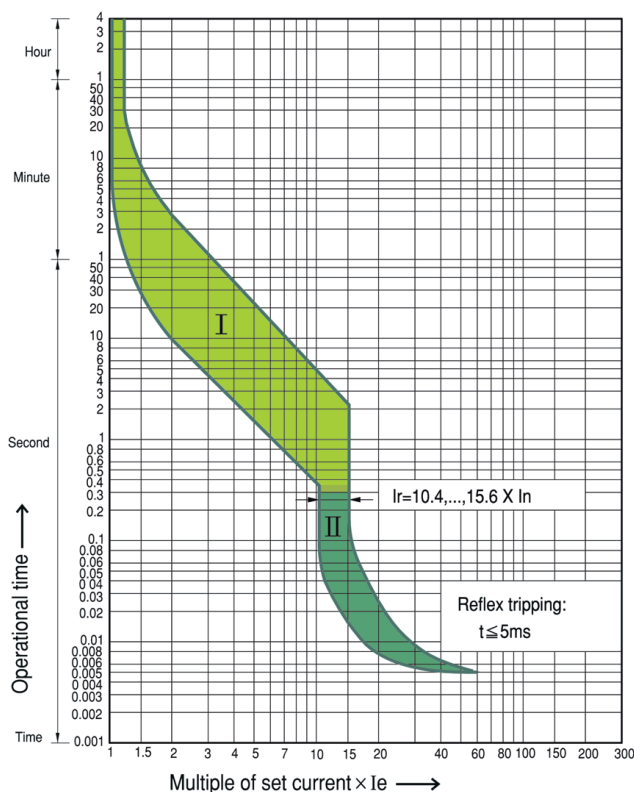

M4-63R, M4-100R

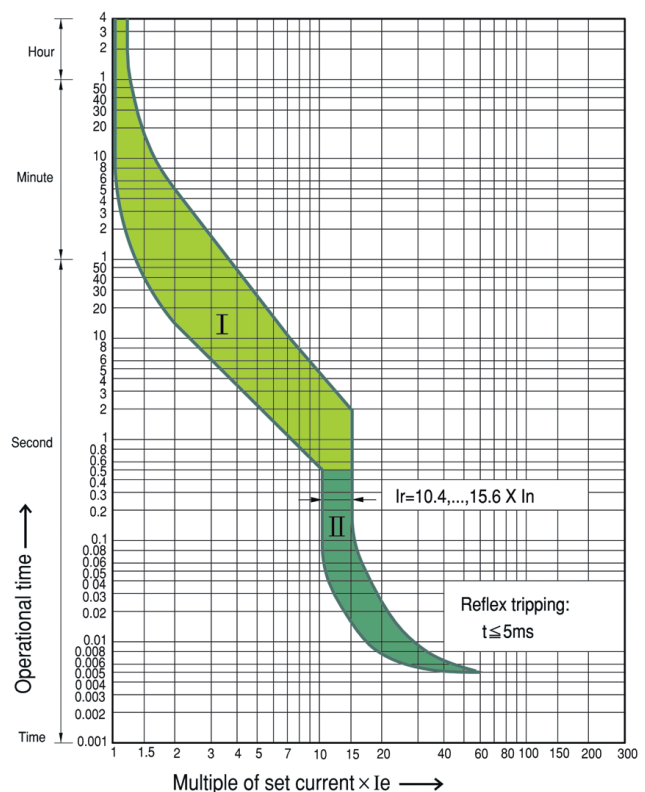

- I The curve shows the mean operating current at an ambient temperature of 20°C starting from cold.
- II The tripping characteristic of electromagnetic overcurrent releases (short-circuit releases)

The tripping characteristic of the inverse-time delayed overload releases apply for DC and AC with a frequency of 0 to 400 Hz. At operating temperature, the tripping times of the thermal releases are reduced to approximately 25 %.

The characteristic shown here is a schematic representation of circuit-breakers for all ranges. Current limiting characteristics and I²t characteristics are available on request.

Let-through Energy (I^2t / kA^2s) and Peak Current (I_p / kA) at $U_e=415\text{V}$

M4-32R

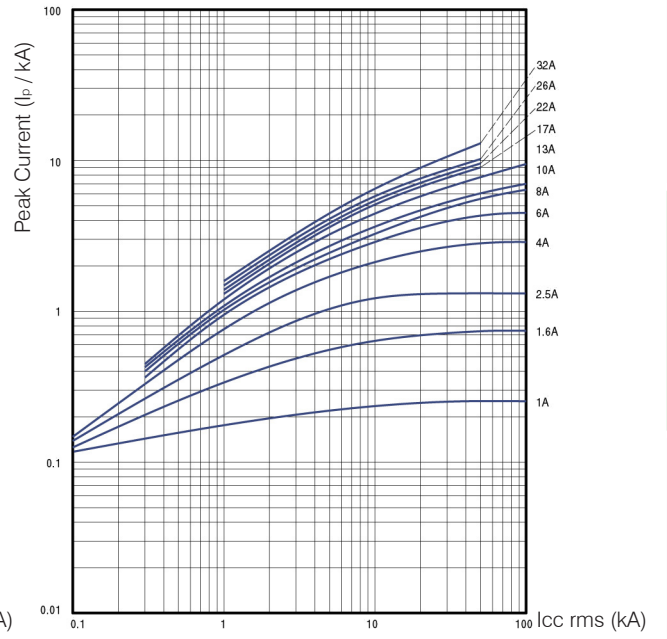
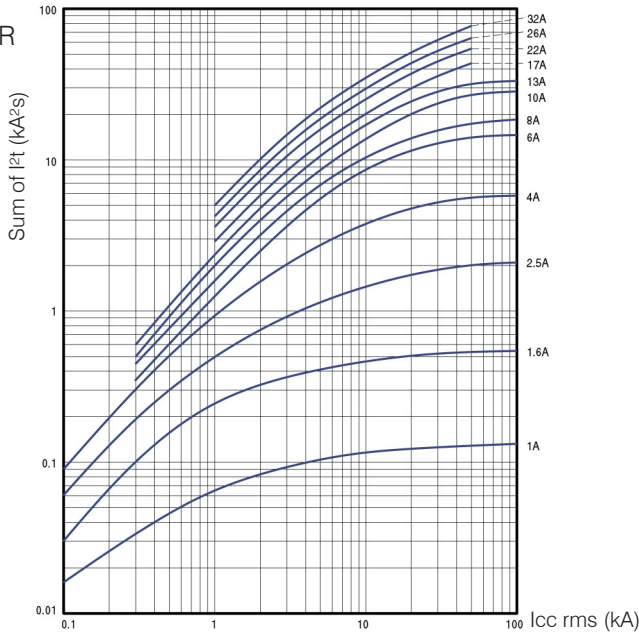

M4-63R

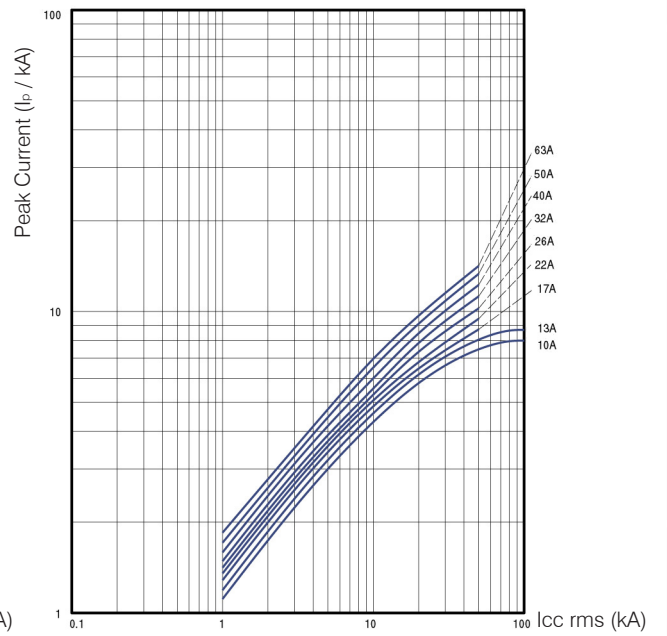
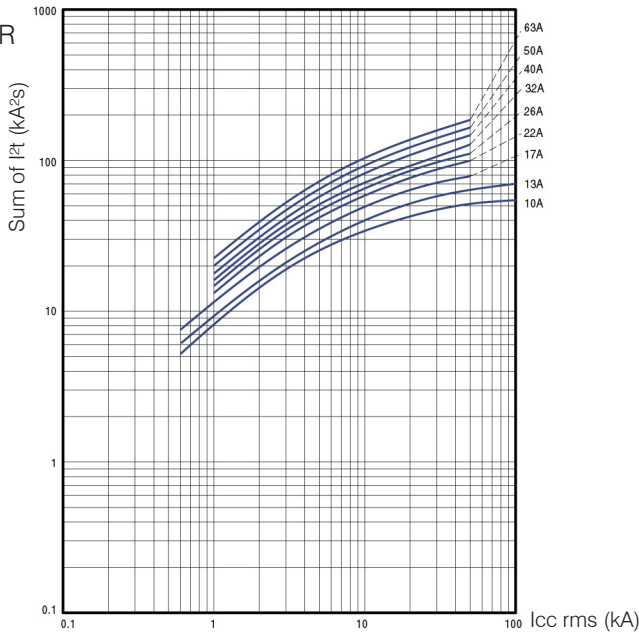

M4-100R

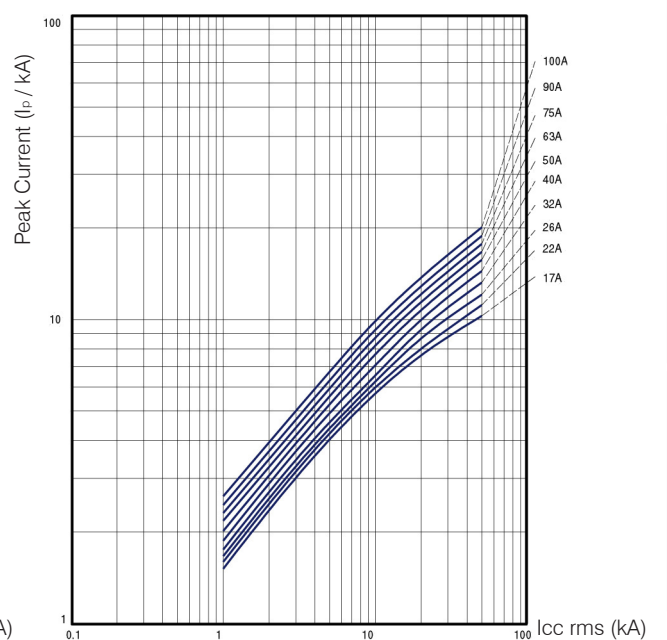
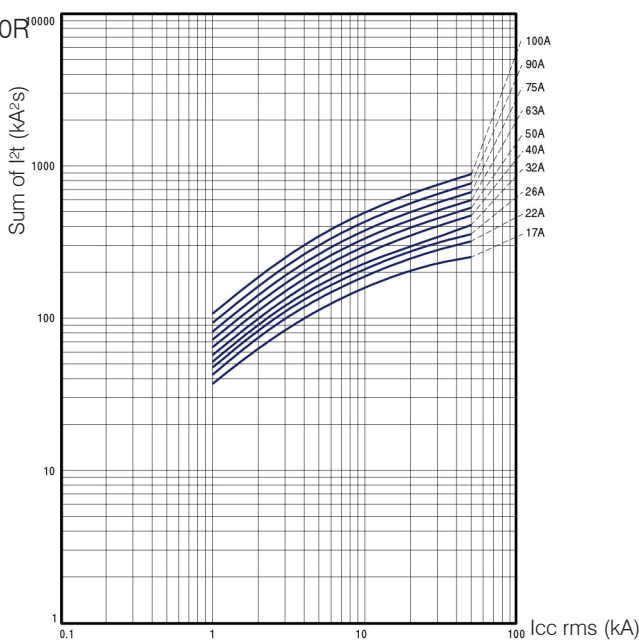

Circuit Breakers M4 for Motor Control



Technical Information IE3-Motor

Rated Current In A	Instantaneous Short Circuit Release A	Setting range Thermal Overload Release A		Instantaneous Short Circuit Release Ratio A	
		Min	Max	Min	Max
Circuit Breakers M4-32T-..., M4-32R-..					
0,16	2,1	0,1	0,16	21	13
0,25	3,3	0,16	0,25	20	13
0,4	5,2	0,25	0,4	21	13
0,63	8,2	0,4	0,63	21	13
1	13	0,63	1	21	13
1,6	20,8	1	1,6	21	13
2,5	32,5	1,6	2,5	20	13
4	52	2,5	4	21	13
6	78	4	6	20	13
8	104	5	8	21	13
10	130	6	10	22	13
13	169	9	13	19	13
17	221	11	17	20	13
22	286	14	22	20	13
26	338	18	26	19	13
32	416	22	32	19	13
40	520	28	40	19	13



Circuit Breakers M4-63R-..					
10	130	6	10	22	13
13	169	9	13	19	13
17	221	11	17	20	13
22	286	14	22	20	13
26	338	18	26	19	13
32	416	22	32	19	13
40	520	28	40	19	13
50	650	34	50	19	13
63	819	45	63	18	13
65	845	47	65	18	13



Circuit Breakers M4-100R-..					
17	221	11	17	20	13
22	286	14	22	20	13
26	338	18	26	19	13
32	416	22	32	19	13
40	520	28	40	19	13
50	650	34	50	19	13
63	819	45	63	18	13
75	975	55	75	18	13
90	1170	70	90	17	13
100	1300	80	100	16	13



- What is the IE3?

Motor is rated from IE1 through IE4 depends on its energy efficiency which means IE3 is more efficient compared to IE1 and IE2-rated motors.

IEC 60034-30 standard specifies IE classes for motors in accordance with the above requirements. Therefore, consumers must comply with the standard when using Circuit Breaker products.

- IE1 Standard Efficiency
- IE2 High Efficiency
- **IE3 Premium Efficiency**
- IE4 Super Premium Efficiency Was bedeutet IE3?

Pay attention that the ratio between inrush current and rated current of the motor is smaller than the instantaneous short circuit release ratio of the Circuit Breaker for Motor Control.

Mounting

DIN-rail mounting

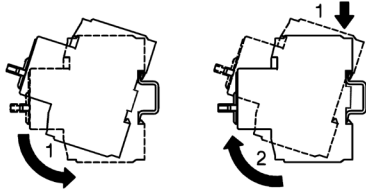

Operating positions

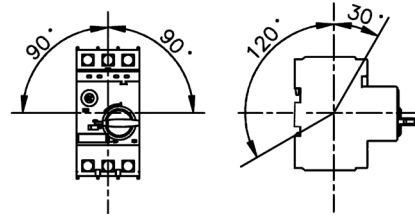

Current setting (dont rotate the dial out of the shown range)

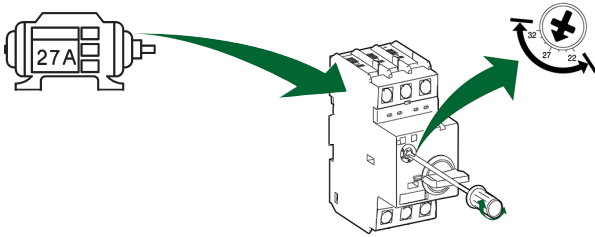

Connection of 1-phase motor



Wiring diagrams

Circuit breaker

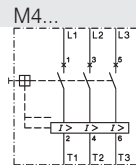

Traverse Aux. Contact Block

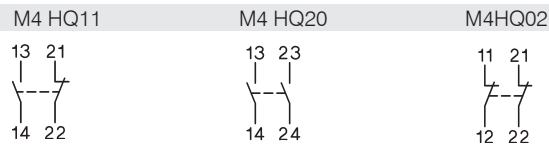

Aux. Contact Block (side mounted)

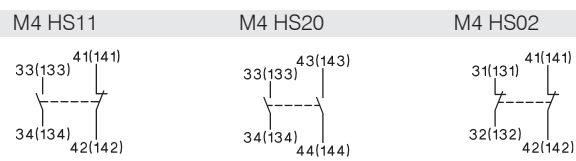

Alarm Switch

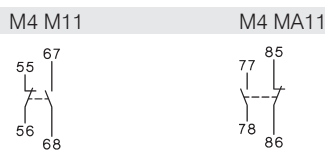

Undervoltage Release

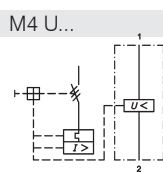

Shunt Release

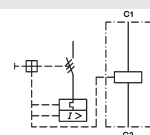

Installation of accessories

M4-32T
M4-32R

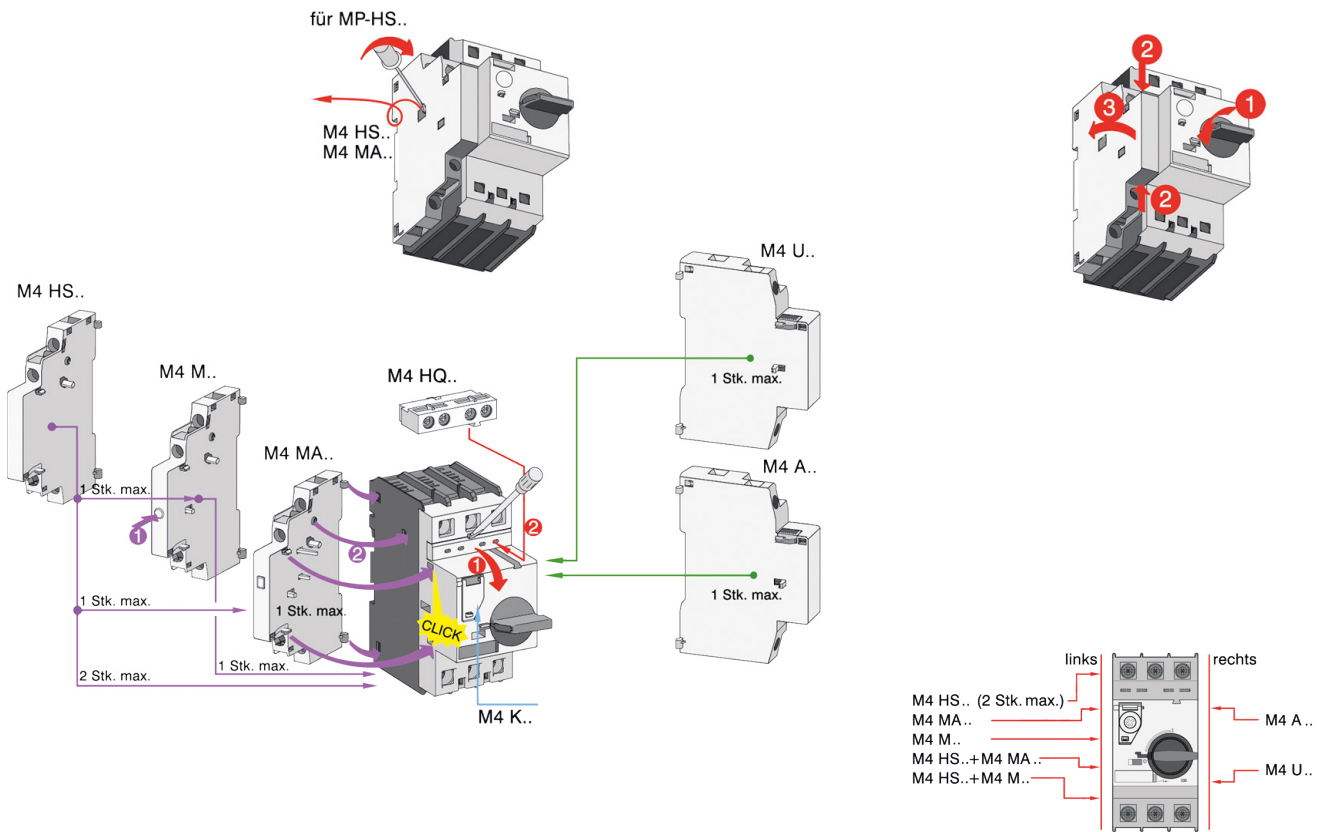

M4-63R
M4-100R

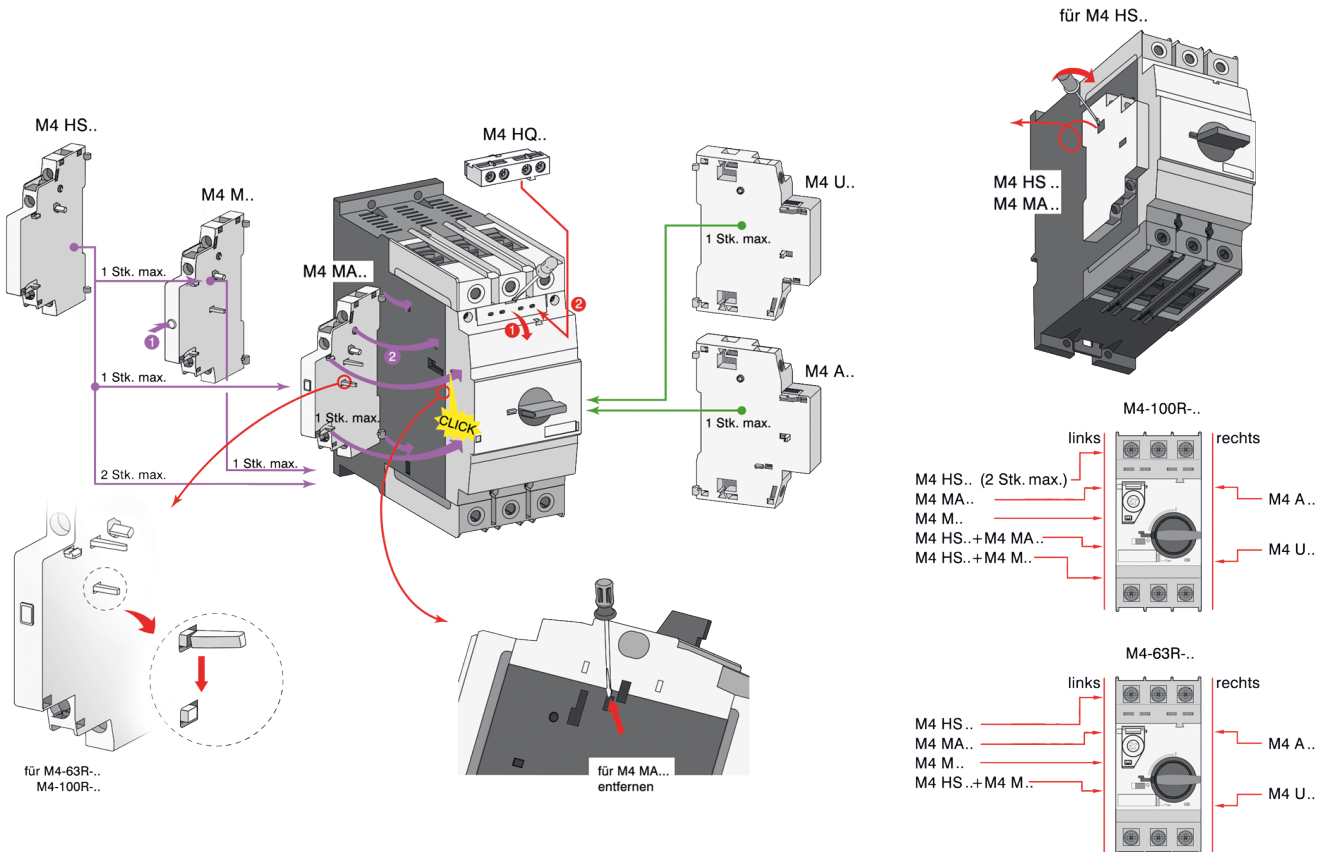

Dimensions

Circuit-breaker M4-32T

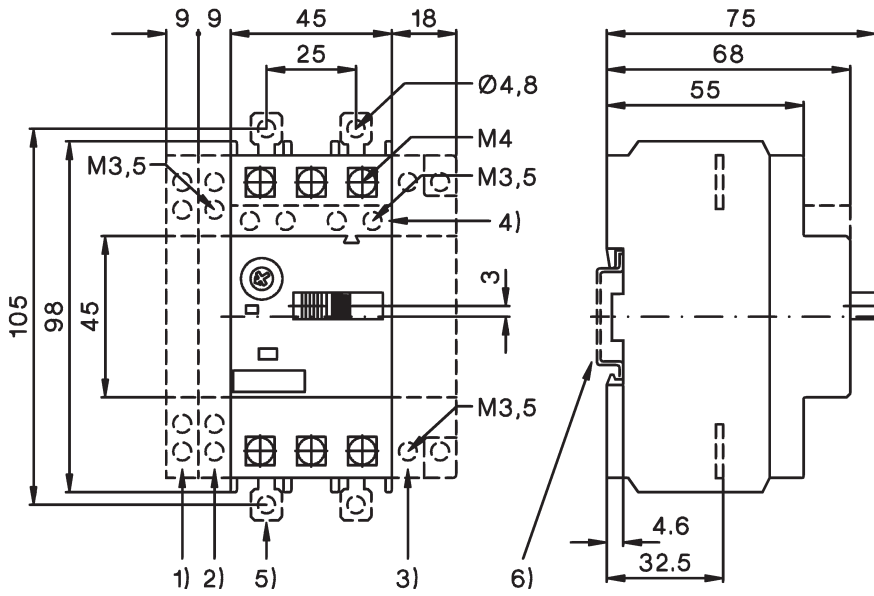

- 1) Side aux. contact
- 2) Magnetic trip alarm
- 3) Shunt or undervoltage release of arcing
- 4) Transverse aux. contact
- 5) Push-in Lugs for screw mounting
- 6) 35mm DIN-rail acc. to EN 50022

Height of arcing spaces (clearance from earthed parts)

at Ue (V)	240	415	460	525	690
mm	20	20	20	20	20
inch	0,8	0,8	0,8	0,8	0,8

Circuit-breaker M4-32R

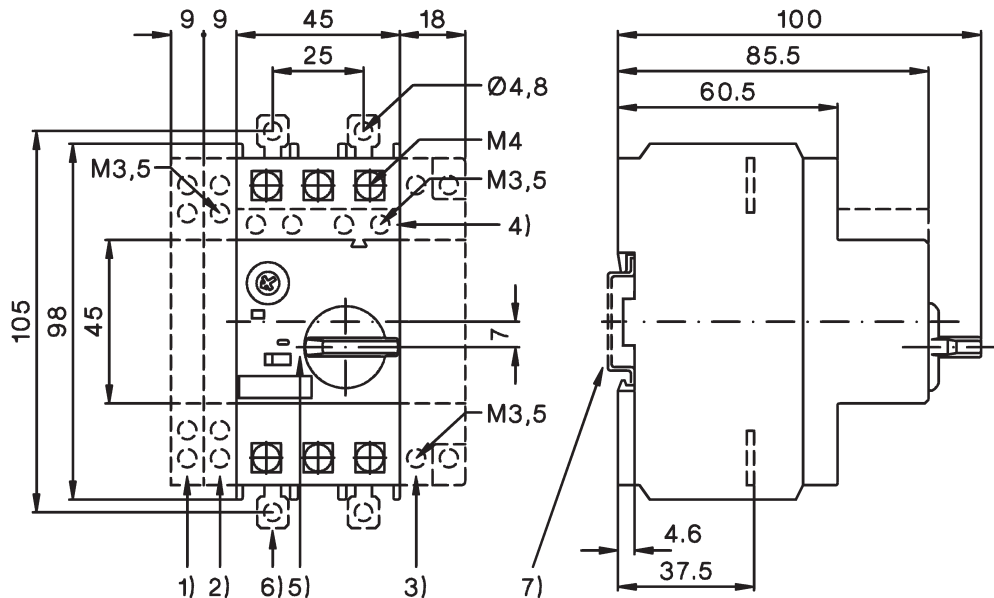

- 1) Side aux. contact
- 2) Magnetic trip alarm
- 3) Shunt or undervoltage release of arcing
- 4) Transverse aux. contact
- 5) Handle lock in OFF-position (Ø 5mm)
- 6) Push-in Lugs for screw mounting
- 7) 35mm DIN-rail acc. to EN 50022

Height of arcing spaces (clearance from earthed parts)

at Ue (V)	240	415	460	525	690
mm	30	30	30	30	50
inch	1,18	1,18	1,18	1,18	2

Dimensions

Circuit-breaker M4-63R

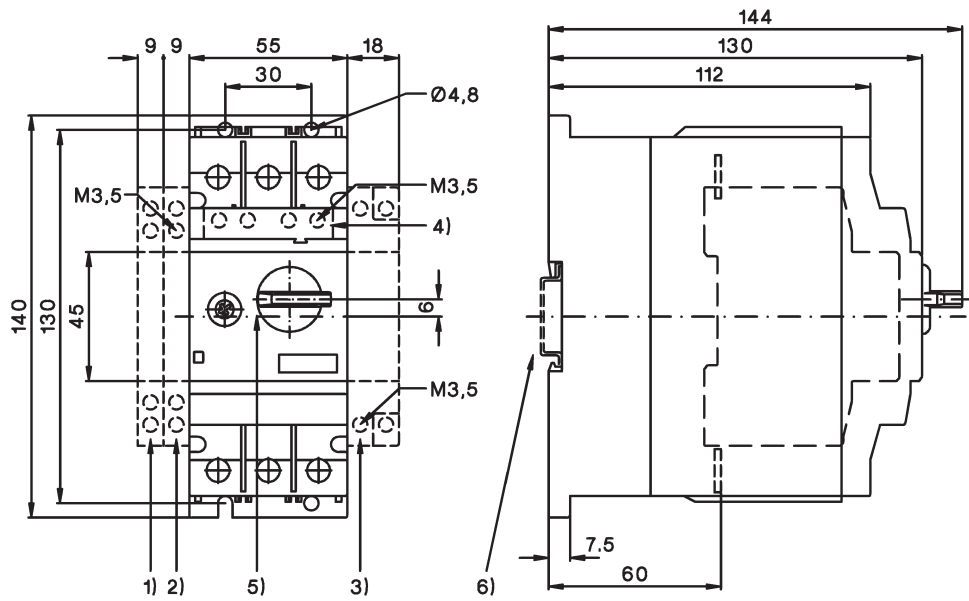

Height of arcing spaces (clearance from earthed parts)

at U _e (V)	240	415	460	525	690
mm	50	50	50	50	50
inch	2	2	2	2	2

- 1) Side aux. contact
- 2) Magnetic trip alarm
- 3) Shunt or undervoltage release
- 4) Transverse aux. contact
- 5) Handle lock in OFF-position (Ø 5mm)
- 6) 35mm DIN-rail acc. to EN 50022

Circuit-breaker M4-100R

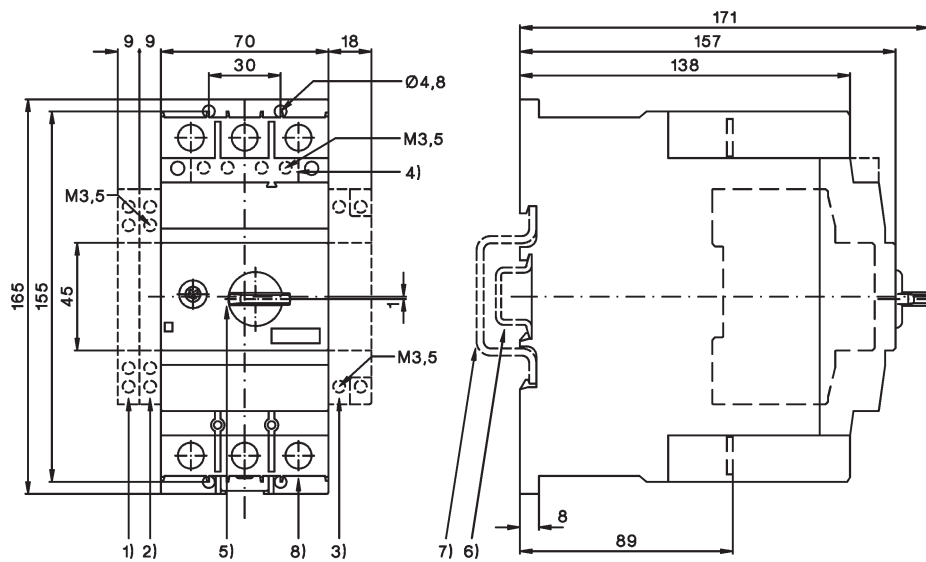

Height of arcing spaces (clearance from earthed parts)

at U _e (V)	240	415	460	525	690
mm	50	70	70	110	150
inch	2	2¾	2¾	4,33	6

- 1) Side aux. contact
- 2) Magnetic trip alarm
- 3) Shunt or undervoltage release
- 4) Transverse aux. contact
- 5) Handle lock in OFF-position (Ø 5mm)
- 6) 35mm DIN-rail acc. to EN 50022
- 7) 70mm DIN-rail acc. to EN 50023
- 8) 4mm hexagon socket screw

Dimensions

Link Module M4 32 VK1

M4-32T + K1- . .

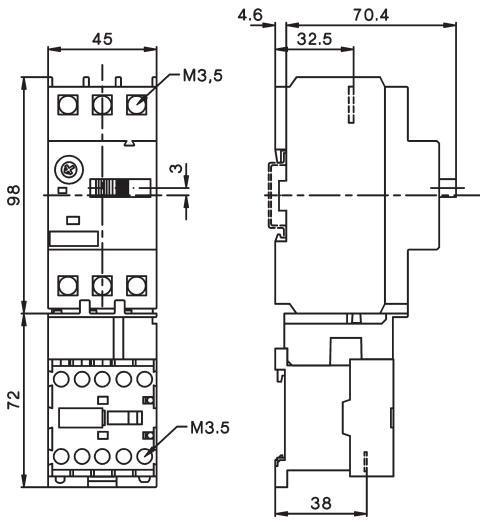

M4-32R + K1- . .

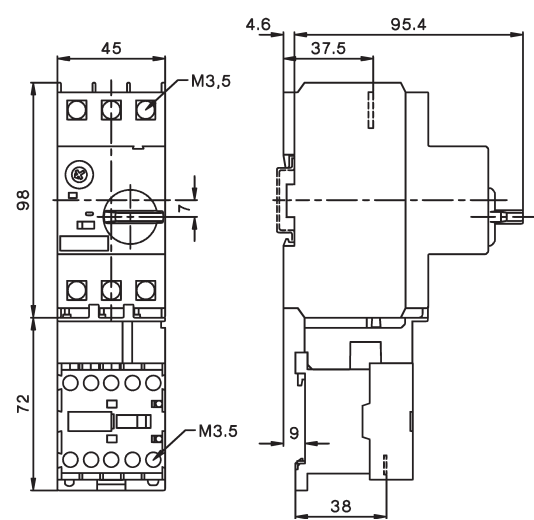

Link Module M4 32 VK3

M4-32T + K3-10ND. .
M4-32T + K3-18ND. .

M4-32T + K3-14ND. .
M4-32T + K3-22ND. .

M4-32R + K3-10ND. .
M4-32R + K3-18ND. .

M4-32R + K3-14ND. .
M4-32R + K3-22ND. .

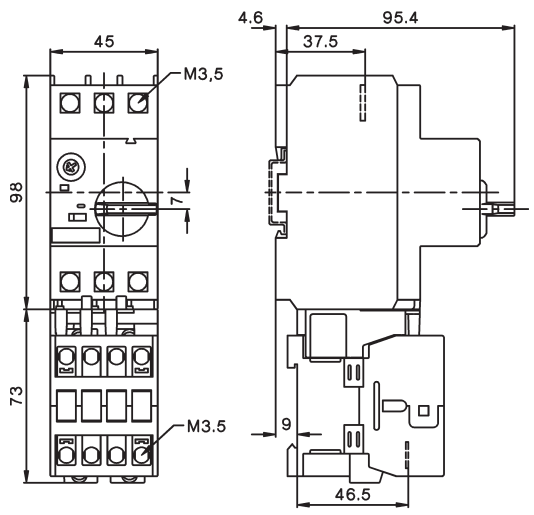
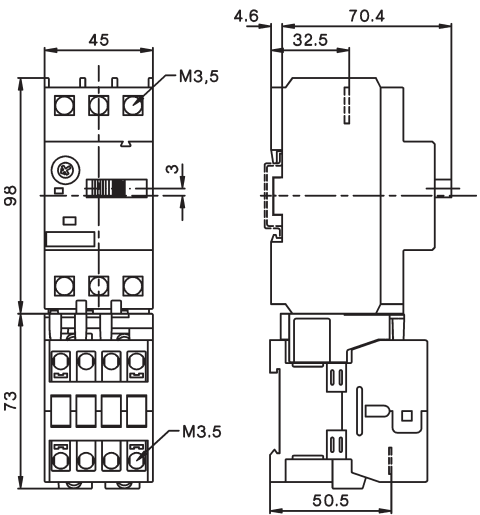

Link Module M4 32 VKG3

M4-32T + KG3-10. .
M4-32T + KG3-18. .

M4-32T + KG3-14. .
M4-32T + KG3-22. .

M4-32R + KG3-10. .
M4-32R + KG3-18. .

M4-32R + KG3-14. .
M4-32R + KG3-22. .

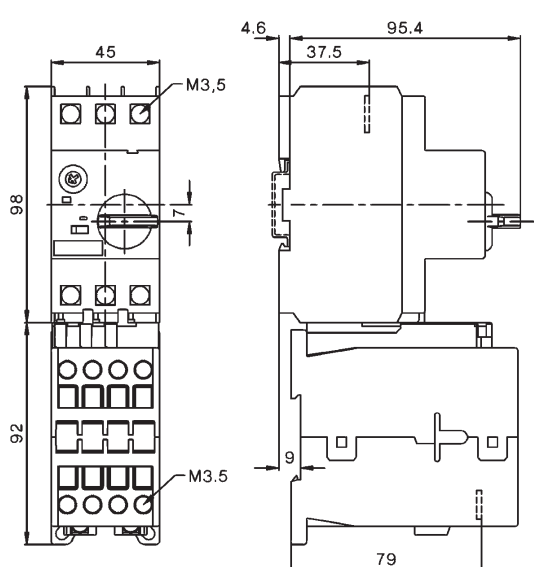
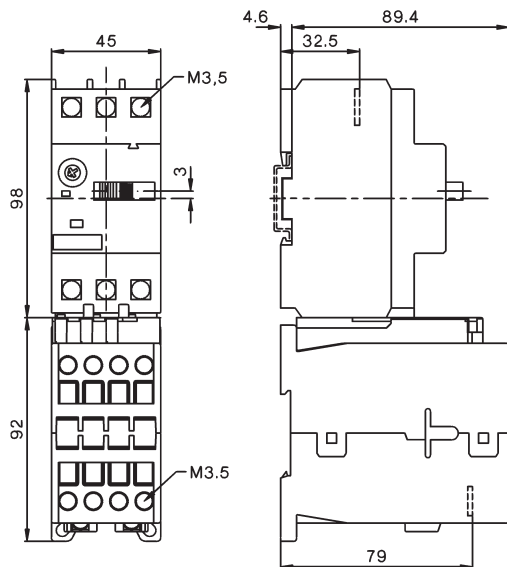

Dimensions

DIN-rail adapter M4 32 HU1

M4-32T + K3-24 + M4 32VD
 M4-32T + K3-32 + M4 32VD

M4-32R + K3-24 + M4 32VD
 M4-32R + K3-32 + M4 32VD

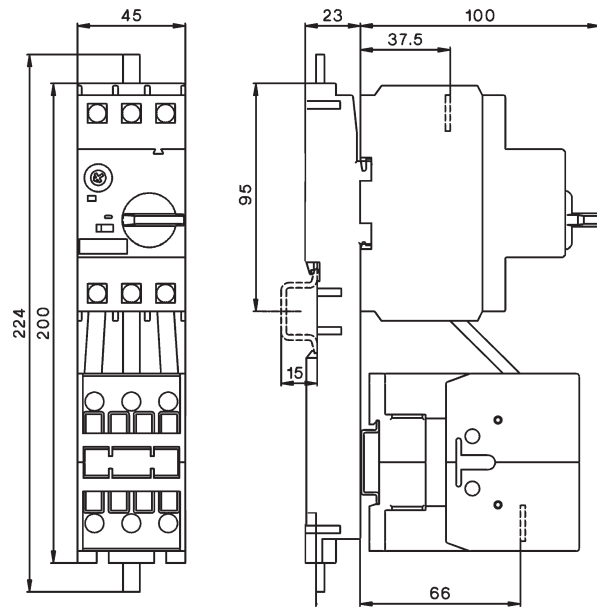
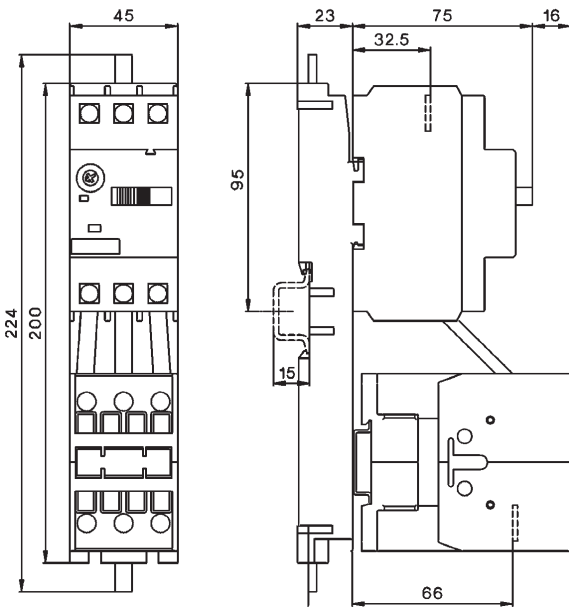

DIN-rail adapter M4 32 HU1

M4-32T + KG3-24 + M4 32 VD
 M4-32T + KG3-32 + M4 32 VD

M4-32R + KG3-24 + M4 32 VD
 M4-32R + KG3-32 + M4 32 VD

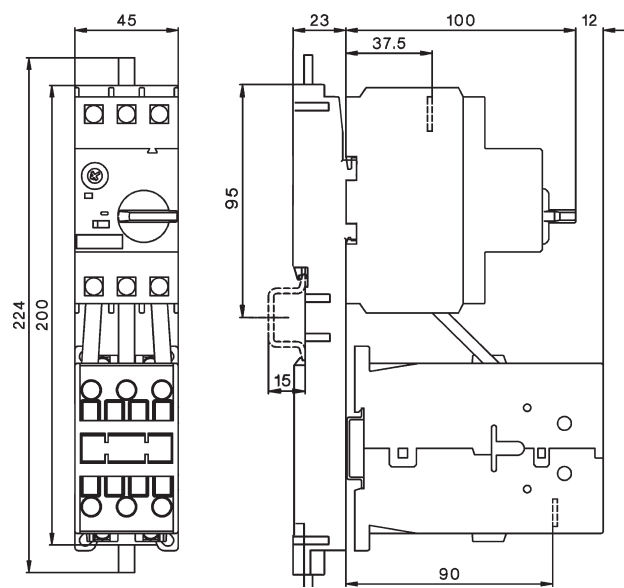
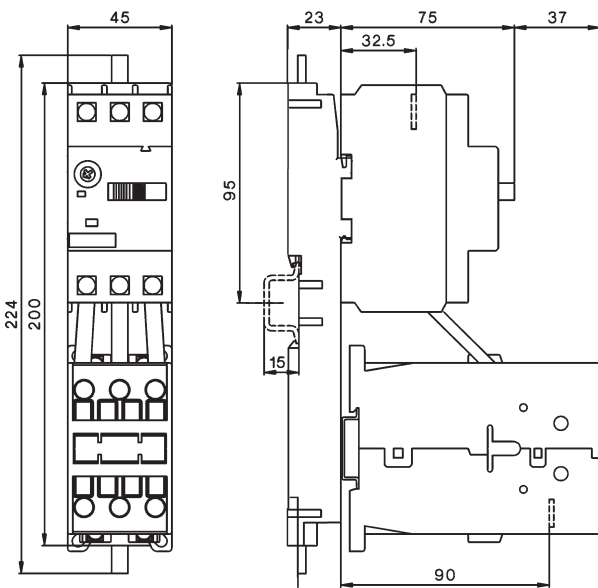

Dimensions

DIN-rail adapter M4 63 HU1

M4-63T + K3-32 + M4 63 VD
 M4-63T + K3-40 + M4 63 VD

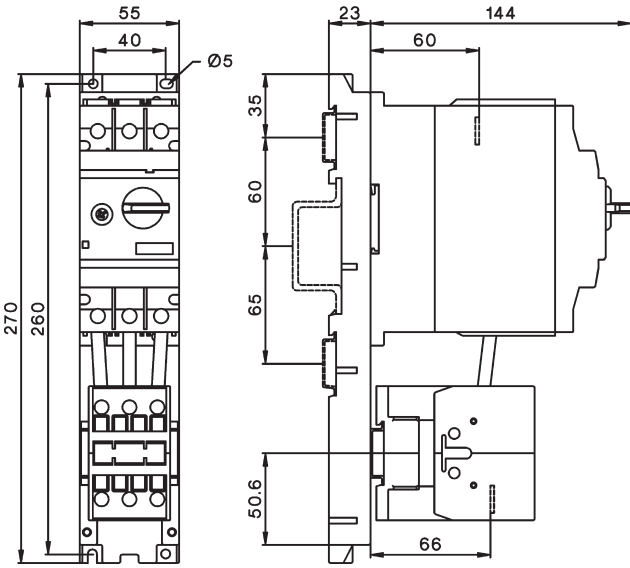

M4-63T + KG3-32 + M4 63 VDG
 M4-63T + KG3-40 + M4 63 VDG

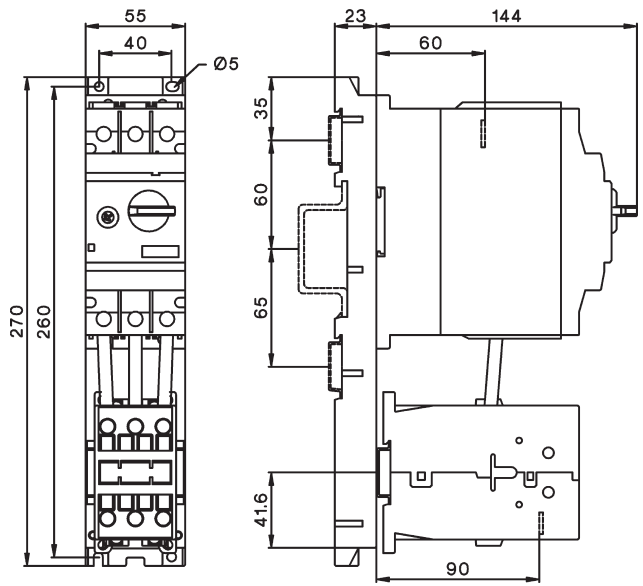

DIN-rail adapter M4 63 HU1

M4-63T + K3-50 + M4 63 VD
 M4-63T + K3-62 + M4 63 VD

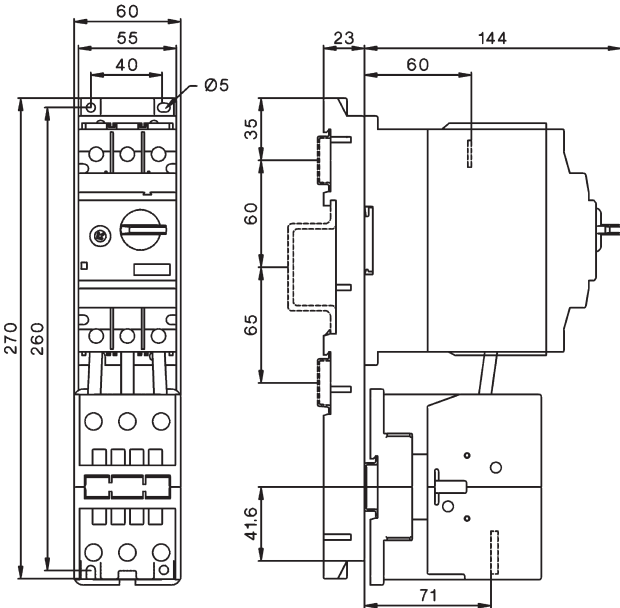

DIN-rail adapter M4 100 HU1

M4-100R + K3-62 + M4 100 VD
 M4-100R + K3-74 + M4 100 VD

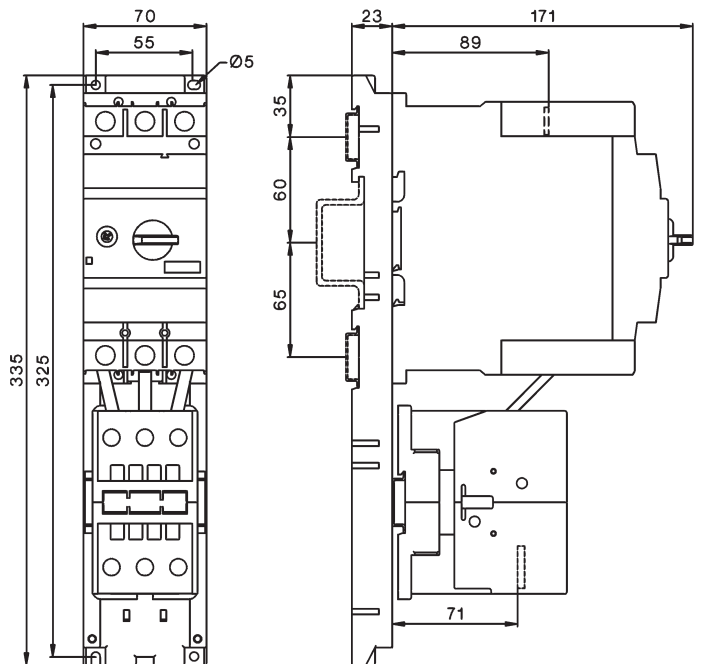

Dimensions

Enclosures

M4 32R PFH4
M4 32R PFHN4

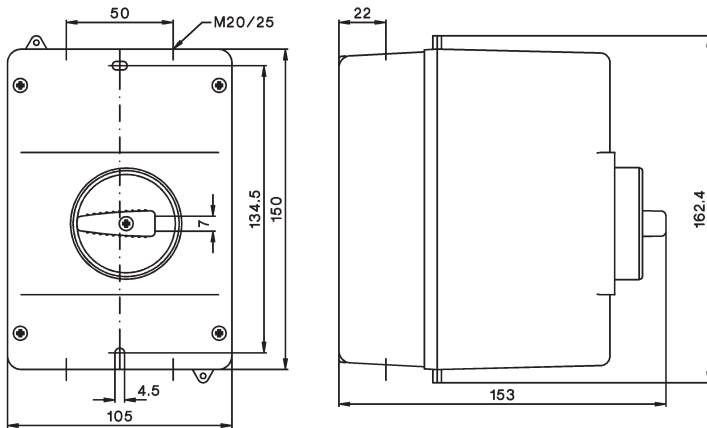

Door-coupling rotary mechanisms

Mounting holes

Type	A
M4 32R EH1 115	149 - 210
M4 32R EHN1 115	149 - 210
M4 32R EH1 315	149 - 410
M4 32R EHN1 315	149 - 410

Type	A
M4 63R EH1 115	194 - 255
M4 63R EHN1 115	194 - 255
M4 63R EH1 315	194 - 455
M4 63R EHN1 315	194 - 455

Type	A
M4 100R EH1 115	220 - 282
M4 100R EHN1 115	220 - 282
M4 100R EH1 315	220 - 482
M4 100R EHN1 315	220 - 482

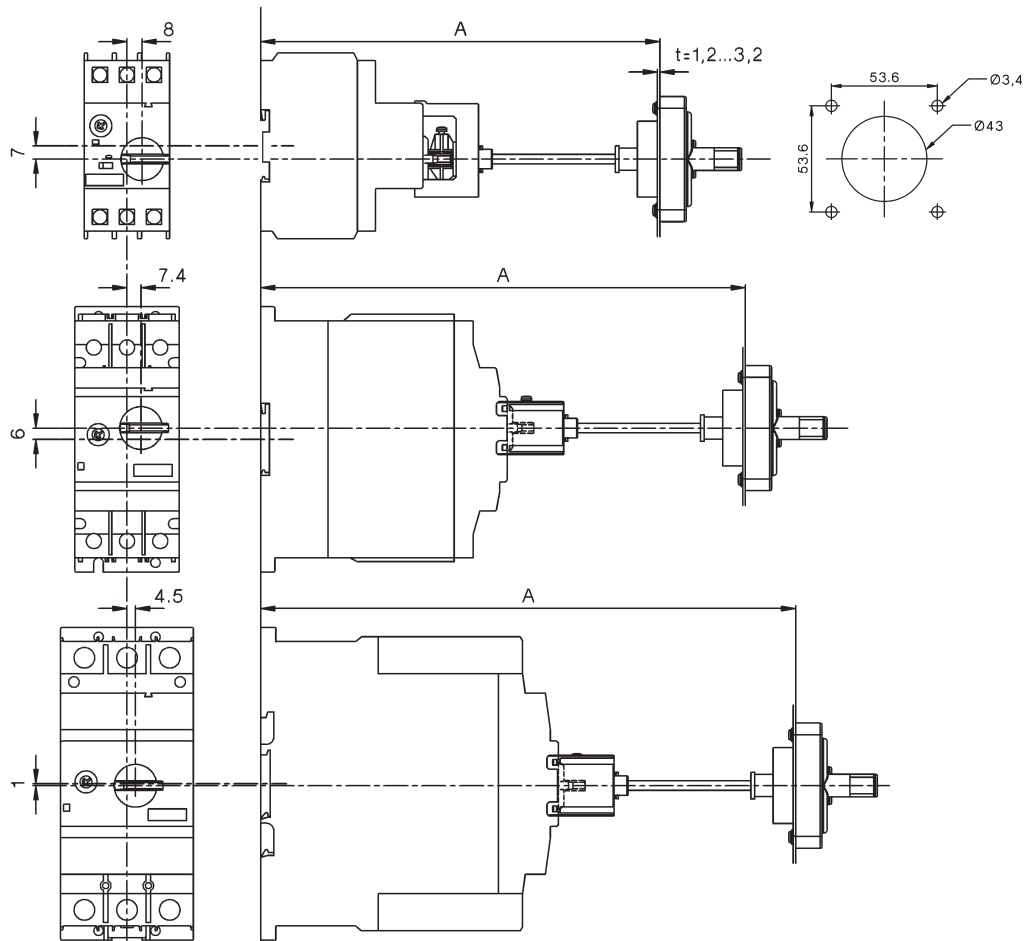

Insulated 3-phase busbar system

M4 32 S..

